

# Chemistry 2B

# Lab Manual

Standard Operating Procedures

# Spring Quarter 2024

Department of Chemistry  
University of California - Davis  
Davis, CA 95616

Student Name \_\_\_\_\_

Locker # \_\_\_\_\_

### Laboratory Information

Teaching Assistant's Name \_\_\_\_\_

Laboratory Section Number \_\_\_\_\_

Laboratory Room Number \_\_\_\_\_

Dispensary Room Number **1060 Sciences Lab Building**

### Location of Safety Equipment Nearest to Your Laboratory

Safety Shower \_\_\_\_\_

Eye Wash Fountain \_\_\_\_\_

Fire Extinguisher \_\_\_\_\_

Fire Alarm \_\_\_\_\_

Safety Chemicals \_\_\_\_\_

# Preface

---

Chemistry is an experimental science. Thus, it is important that students of chemistry do experiments in the laboratory to more fully understand that the theories they study in lecture and in their textbook are developed from the critical evaluation of experimental data. The laboratory can also aid the student in the study of the science by clearly illustrating the principles and concepts involved. Finally, laboratory experimentation allows students the opportunity to develop techniques and other manipulative skills that students of science must master.

The faculty of the Chemistry Department at UC Davis clearly understands the importance of laboratory work in the study of chemistry. The Department is committed to this component of your education and hopes that you will take full advantage of this opportunity to explore the science of chemistry.

A unique aspect of this laboratory program is that a concerted effort has been made to use environmentally less toxic or non-toxic materials in these experiments. This was not only done to protect students but also to lessen the impact of this program upon the environment. This commitment to the environment has presented an enormous challenge, as many traditional experiments could not be used due to the negative impact of the chemicals involved. Some experiments are completely environmentally safe and in these the products can be disposed of by placing solids in the wastebasket and solutions down the drain with copious amounts of water. Others contain a very limited amount of hazardous waste and in these cases the waste must be collected in the proper container for treatment and disposal. The Department is committed to the further development of *environmentally safe experiments* which still clearly illustrate the important principles and techniques.

The sequence of experiments in this Laboratory Manual is designed to follow the lecture curriculum. However, instructors will sometimes vary the order of material covered in lecture and thus certain experiments may come before the concepts illustrated are covered in lecture or after the material has been covered. Some instructors strongly feel that the lecture should lead the laboratory while other instructors just as strongly believe that the laboratory experiments should lead the lecture, and still a third group feel that they should be done concurrently. While there is no “best” way, it is important that you carefully prepare for each experiment by reading the related text material before coming to the laboratory. In this way you can maximize the laboratory experience.

Questions are presented throughout each experiment. It is important that you try to answer each question as it appears in the manual, as it will help you understand the experiment as you do it. In addition, you are encouraged to complete the report as soon after laboratory as possible, as this is much more efficient than waiting until the night before it is due.

In conclusion, we view this manual as one of continual modification and improvement. Over the past few years, many improvements have come from student comments and criticisms. We encourage you to discuss ideas for improvements or suggestions for new experiments with your TA. Finally, we hope you find this laboratory manual helpful in your study of chemistry.





# Acknowledgments

---

This manual is the culmination of the efforts of many individuals.

Many faculty members have provided ideas for the creation of these laboratories and have made numerous suggestions regarding their implementation. Stockroom Dispensary Supervisors, both past and present, have had a role in helping to develop these experiments and, in particular, helping to ensure that the experiments are tailored to our laboratories here at UC Davis. Safety TAs, both past and present, have edited this manual to ensure that the experimental procedures are clear and current. In addition, many undergraduates have been involved in the development of experiments as part of undergraduate research projects.



# Table of Contents

Preface	i
Acknowledgments	iii
Introduction	vii
Experiments	
Thermochemistry	3
General Analytical Techniques	21
Volumetric Analysis	23
Reactions of Copper	39
Colligative Properties	47
A Brief Introduction to Spectrophotometry	61
Spectrophotometry	73
Determination of Avogadro's Number	91
Appendix	
General Experimental Guidelines	A-5
Laboratory Work Grading Policies	A-7
Late Reports & Make-Up Policy	A-8
Chemistry Department Safety Policy	A-9
Safety in the Chemistry 2 Laboratories	A-12
Maps and Emergency Evacuation Procedures	A-16
General Emergency Procedures	A-20
Dispensary Procedures	A-21
Safety Data Sheet	A-22
Hazardous Chemicals	A-31
Statistical Treatment of Data	A-34
An Introduction to Excel	A-38
Common Laboratory Procedures	A-50
Locker Inventory	A-75

## Table of Contents

# Introduction

---

## Time Allocation and Grading

Below is an indication of the time allocation of each experiment. At the end of the quarter, the student's TA will sum the scores and give this to the instructor, who will modify it as described in the course syllabus.

Title of Experiment	Lab Periods Allocated
Thermochemistry	2
General Analytical Techniques	N/A
Volumetric Analysis	2
Reactions of Copper	1
Colligative Properties	1
Spectrophotometry	2
Determination of Avogadro's Number	1
On-Line Prelab Quizzes	N/A
Lab Notebooks - Pre-lab	N/A

**On-Line Pre-laboratory Quizzes:** Each 2 point pre-lab quiz must be completed **at least 1 hour** prior to attending the student's scheduled lab class. All three quiz questions must be answered correctly before the student will be allowed to perform the laboratory experiment. If the quiz is failed on the first attempt, the student has four more attempts to pass the quiz. Because the questions are chosen randomly, different questions may be generated on each attempt. Students who fail these quizzes are considered unprepared and unsafe to work in the laboratory and will not be allowed to begin the laboratory procedure until the TA is convinced the student is prepared. The TA will check the pre-laboratory write-up and quiz the student. The TA will allow entry into the laboratory only if the student answers the questions correctly and the pre-laboratory write-up is complete. This policy will be strictly enforced.

# Safety Policy

It is critical that you prepare for each experiment by reading it carefully before entering the laboratory. Not only will this ensure that you get the maximum benefit of the experience, but it also makes for a safer environment in the laboratory. This is important not only for your own safety but also for those around you. A number of policies have been developed in order to make sure that the laboratory is safe and that it runs smoothly.

In each experiment specific hazards are indicated by bold type and procedures are described that must be adhered to. Accidents commonly occur when the following rules, as approved by the Chemistry Department Safety Committee, are not followed.

### U.C. Davis Department of Chemistry Chem. 2 Series

#### Standard Operating Procedures

#### SAFETY RULES FOR TEACHING LABORATORIES

The following rules are designed for your safety and it is your responsibility to follow these rules. The Laboratory Instructor (LI = TA, Laboratory Supervisor, and/or Course Instructor) must enforce these rules, approved by Department of Chemistry Staff, Faculty, and Department Safety Manager. The LI must also enforce all experiment-specific safety rules pertaining to laboratory work, including rules not explicitly mentioned here. Violation of these rules will result in expulsion from the laboratory.

1. No one is permitted in the lab without the supervision of an LI. No lab work will be done without supervision. Perform only authorized experiments, and only in the manner instructed. Do *not* alter experimental procedures, except as instructed.
2. Specific permission from your LI is required before working in any lab section other than the one assigned to you. Only lab rooms where the same lab course is operating may be used for this purpose.
3. If you have a special health condition (asthma, pregnancy, etc.) or any personal health concerns, consult your medical professional before taking chemistry lab. If you require accommodations such as wheelchair access, service animals, or other, consult with the Department Safety Manager.
4. Students must come to the lab with appropriate lab attire and personal protective equipment (PPE). Without either, you will not be allowed to enter or make-up the lab, and your course grade will be affected. If you cannot wear the required PPE or lab attire, you must meet with the Department Safety Manager before you are allowed to enter the lab.
5. The appropriate PPE requirements include the following:
  - a. Properly-fitted white 100% cotton lab coats. Lab coat sleeves must cover your wrist and should cover your thighs when seated. Disposable, flimsy, short, or dyed lab coats are *not* allowed.

- b. Approved safety goggles must be worn at all times. Safety goggles may not be modified in any manner. Visorgog, safety glasses, swimming goggles, or similar eyewear are not acceptable in the lab.
6. Lab attire must be made of durable material to protect from incidental chemical splash. Appropriate lab attire includes:
  - a. Clothing that completely covers the legs - including the skin between the top of the shoe and the bottom of the pant leg - must be worn at all times in the lab. Leg coverings must extend to the shoes. Socks must be long enough to cover the ankles while seated. Tights, leggings, joggers, yoga pants, pants with holes, pants with slits, etc. are not suitable leg covering regardless of material. No-show socks are *not* allowed.
  - b. Closed-toe, closed-heel shoes that completely cover the entire foot (including the top of the foot) must be worn at all times. Crocs, jellies, boat shoes, low-heel slippers, slides, slip-ons, etc. are not allowed. Socks are not suitable replacements for shoes or leg coverings.
  - c. Because inadequate protection often leads to injury, it is recommended to ensure all skin below the neck is covered.
  - d. Avoid wearing expensive clothing or jewelry to the lab as it may get damaged.
7. All students must adhere to safe lab practices, including the following:
  - a. Horseplay and carelessness are not permitted and are cause for expulsion from the lab.
  - b. You must be fully attentive and aware of your surroundings, and remove distractions as directed by your LI.
  - c. Skateboards, rollerblades, motorized scooters, bicycles, and other transportation devices must be stored outside of the lab. Personal electronics are only permitted when needed for the lab. Cell phones or other personal electronic media can be damaged or contaminated in the lab. Use of such devices is at the student's own risk.
  - d. Tie back long hair, loose hair, or hair that blocks your vision. Pin back loose headwear.
  - e. Absolutely *no* food or drinks are to be stored or consumed in the lab. Contact lenses and cosmetics (hand lotion, lip balm, etc.) are not to be applied, and medications are not to be consumed while in the lab.
  - f. Lab doors must remain closed except when individuals are actively entering or exiting the lab.
  - g. The student must have at least *one ungloved hand* when outside the lab. Gloves are presumed to be contaminated and must not come into contact with anything outside the lab except chemical containers. Only use the ungloved hand to open doors, hold on to stair rails, or push elevator buttons.
8. Follow all instructions on safe chemical handling and safe equipment handling, including the following:
  - a. Mouth suction must never be used to fill pipets.
  - b. All activities in which toxic gases or vapors are used or produced must be carried out in the fume hood.

## Introduction

- c. Containers of chemicals may not be taken out of the lab except to the dispensary for refill/ replacement or to exchange full waste jugs for empty ones. All containers must be closed with the appropriate cap before you take them into the hallway to the dispensary. Always use a bottle carrier when transporting chemicals and waste.
  - d. Put hazardous waste into appropriate waste container(s) provided in your lab. Do not overfill waste containers.
  - e. Keep your working area clean – immediately clean up *all* spills or broken glassware. Dispose sharps in the appropriate container. Do not dispose pipette tips in regular trash. Clean off your lab workbench before leaving the lab.
9. Learn how to respond to emergencies and report incidents promptly to the LI:
- a. Learn the location and how to operate the nearest eyewash fountain, safety shower, fire extinguisher, and fire alarm box. Basic first aid for any chemical splash is to wash the affected area for at least 15 minutes and seek medical attention. Use the emergency shower if appropriate, removing contaminated clothing for thorough washing. If the safety shower or eyewash is activated, the exposed person should be accompanied to the Student Health Center for further evaluation.
  - b. All incidents, near misses, injuries, explosions, or fires must be reported at once to the LI. In case of serious injury or fire (even if the fire is out), the LI must call 911. The student must always be accompanied to the Student Health Center.

Students must sign the Safety Acknowledgement sheet before working in the lab. If you have any questions, please ask your LI before starting any lab work.



# Experiments



# Thermochemistry

## Introduction

---

Welcome to the Chemistry 2B Laboratory. During this first laboratory period you will go over the laboratory safety rules, become acquainted with the layout and equipment in the laboratory, and check-out the equipment in your locker. Then you will begin the first experiment of the quarter, which involves one of the most important areas of science, thermodynamics.

### Locker Check-in

Make sure your locker contains all of the proper equipment in the correct quantities. Please look in the Appendix of this manual for a locker list and drawings of common laboratory equipment. If you are missing any items, first check the box of extra glassware that is located at the back of the laboratory. If you still cannot find the missing equipment, visit the stockroom (Esau Hall 1060). They will give you the glassware that you are missing. Please replace all missing equipment the first day of laboratory since the stockroom is only prepared to replace glassware during the first week. Place extra glassware in the box at the back of the room.

### Thermochemistry Experiment

This experiment is an introduction to the basic principles of thermochemistry and involves the exchange of energy as heat. The ideas and concepts involved in thermodynamics are illustrated in your everyday experiences. For example, on a hot summer day the hood of a car can get hotter than the sidewalk cement and when cooking, you have probably noticed that a wooden spoon does not heat as fast as metal one. After completing this experiment, you will better understand the reasons behind these and other thermal phenomena.

In the first part of this experiment you will construct a simple “coffee-cup” calorimeter. A **calorimeter** is an object used to measure change in heat during a chemical reaction. When used properly, this calorimeter can give very good results. In the next part of the experiment you will measure the specific heat of an unknown solid. Specific heat and heat capacity is discussed later in this introduction. In the third and fourth parts of the experiment, you will determine the enthalpies,  $\Delta H_{\text{rxn}}$ , of endothermic and exothermic reactions. In the fifth part of the experiment, you will design your own procedure to determine the heat of fusion,  $\Delta H_{\text{fus}}$ , of water.

The **enthalpy** ( $H$ ) of a system is the sum of internal energy and the product of pressure and volume. When a reaction occurs at constant pressure, as it will in this experiment, enthalpy is equal to the change in heat of the system. In an **exothermic reaction**, the reaction releases heat, implying that the

### Safety First

After reviewing the safety rules with your TA, sign the back of the safety sheet and return it to your TA.

Remember to always follow the safety instructions when performing all experiments!

**Wear your goggles!**

products are of lower energy than the reactants ( $\Delta H_{\text{rxn}}$  is negative). However, in an **endothermic reaction**, heat is absorbed, indicating that the products are higher in energy ( $\Delta H_{\text{rxn}}$  is positive). What provides the driving force for an endothermic reaction? In order to make sense of your observations for the third and fourth parts of the experiment you will need to consider an additional concept.

The answer to this question is **entropy**, symbolized as **S**. Entropy will be fully discussed later in the course, but a brief introduction is provided here. When entropy is discussed in chemistry, attention is focused on the number and motion of particles in a system. A reaction that results in an increase in the total moles of particles ( $n_f - n_i > 0$ ) is said to have an increase in entropy ( $\Delta S > 0$ ). Entropy also depends, in part, upon particle distribution in space and also on the distribution of energy (and motion) among the particles. The more freedom particles have to move around, the more entropy they will have. Changing a specific sample of a solid to a liquid does not increase the number of moles of the sample, but the energy and motion of the molecules does increase. Therefore, the entropy of the sample has increased. Changing the liquid to a gas dramatically increases the entropy of the system. Similarly, dissolving a salt in water will increase the entropy because the particles go from a very organized crystal to a less organized solution of free-moving ions.

Nature tends to minimize enthalpy ( $\Delta H$ ) and maximize entropy ( $\Delta S$ ). Entropy can therefore be a driving force for a reaction since greater entropy is a preferred condition. **Endothermic** reactions occur because entropy increases. The gain from increasing entropy ( $+\Delta S$ ) in these reactions is enough to counterbalance the unfavorable enthalpic conditions ( $+\Delta H$ ).

Increasing the entropy of a system has the same effect as minimizing the enthalpy of the system—it drives the reaction forward. You will look at reactions that vary in their enthalpic and entropic properties in the third and fourth parts of this experiment. You will see that one of the reactions is enthalpy-favored ( $-\Delta H$ ) but not entropy-favored ( $-\Delta S$ ), one is entropy-favored ( $+\Delta S$ ) but not enthalpy-favored ( $+\Delta H$ ), and one is favored by both enthalpy ( $-\Delta H$ ) and entropy ( $+\Delta S$ ).

Finally, in the last part of this experiment you will design your own procedure to determine the heat of fusion for ice,  $\Delta H_{\text{fus}}$ . Please note that you must come to the laboratory with an outline of the procedure you plan to use. **As preparation for this experiment, you should read the section on thermochemistry in your textbook.**

**Background: Heat, Specific Heat, Heat Capacity, and Molar Heat Capacity**

All parts of this experiment require the use of a calorimeter. In the first part of this experiment, you will construct an inexpensive but effective coffee-cup calorimeter. Before you can use this calorimeter to determine thermodynamic quantities you must determine the **heat capacity** of the calorimeter itself. You will do this by adding a weighed sample of hot water to a known amount of cold water in the calorimeter and measuring the temperature change.

The amount of energy required to change the temperature of an object or a sample of a substance by one degree Celsius or Kelvin is called that object's

**heat capacity:**  $C$  ( $J/^\circ C$ )

There are two variations on heat capacity that you also need to be familiar with:

**specific heat:**  $C_p$  ( $J/(g^\circ C)$ )

and

**molar heat capacity:**  $J/(\text{mol } ^\circ C)$

The specific heat of a substance is the heat required to raise the temperature of **one gram** of the substance one degree, and the molar heat capacity is the amount of energy required to raise **one mole** of the substance by one degree. All substances have characteristic specific heats and molar heat capacities.

When two substances having different temperatures come into contact, energy in the form of heat is exchanged between them until they reach a common temperature. If they are insulated from their surroundings, the amount of heat lost from the hotter substance equals the heat gained by the colder one. The heat lost or gained is related to the mass, the specific heat of the substance, and the temperature change. This relationship is expressed as

$$q = m \times C_p \times \Delta T$$

where  $q$  is the heat,  $m$  is the mass,  $C_p$  is the specific heat of that substance, and  $\Delta T$  is the change in temperature. This equation can also be used if moles are substituted for mass, and molar heat capacity is substituted for specific heat. In this experiment, you will determine the heat capacity of your calorimeter.

When dealing with the calorimeter itself, you will combine the mass and specific heat of the calorimeter into a single term, the calorimeter's heat capacity. This can be done since the mass of the calorimeter does not change.

$$q = C^{\text{calorimeter}} \times \Delta T$$

**Calorimetry, it's the bomb!**

Have you ever looked at a nutrition label and wondered how the manufacturer determined the number of Calories in that food? For many foods, the answer lies within bomb calorimetry. A bomb calorimeter works similarly to a coffee cup calorimeter, with the exception that the reaction takes place inside a sealed chamber with a set volume (the "bomb"). When a piece of food is combusted within the chamber, the change in temperature of water surrounding the bomb calorimeter can be used to determine the energy content of the food. The energy content is then converted to Calories. A Calorie is equal to the amount of heat required to raise 1 gram of pure water by 1°C. In other words, a Calorie is the specific heat of water, and equals 4.184 Joules. It's important to note that some countries use "Calorie" (with an uppercase c) on their nutrition labels, while others use "calories" (with a lowercase c) or "kilocalories" (kcal). 1 Calorie = 1 kcal = 1000 calories.

## Learning Goals

---

The following is a list of skills that you will use in this experiment.

<b>Laboratory</b>	<ul style="list-style-type: none"> <li>• Constructing a coffee cup calorimeter</li> <li>• Using a hot plate</li> <li>• Using a balance</li> </ul>
<b>Conceptual</b>	<ul style="list-style-type: none"> <li>• Enthalpy</li> <li>• Exo- and endothermic reactions</li> <li>• Heat and the flow of heat</li> <li>• Heat capacity, specific heat capacity, and molar heat capacity</li> </ul>
<b>Data Analysis</b>	<ul style="list-style-type: none"> <li>• Calculating heat capacity using <math>q = C\Delta T</math> or <math>q = mC_p\Delta T</math></li> <li>• Calculating change in enthalpy of a reaction using</li> <li>• <math>\Delta H = q/mole</math></li> </ul>

## Procedure

---

**Work in pairs** on this experiment.

Each student must collect data and submit a separate report. The actual data analyses and the written reports must be done entirely independently of your lab partner or other students. Make sure that you avoid unauthorized collaboration and plagiarism. All suspected violations of the Code of Academic Conduct will be referred to Student Judicial Affairs.

### Stock Chemicals Used

Chemical	Maximum Amount Used
6 M Hydrochloric Acid	< 15 mL
6 M Sodium Hydroxide	< 15 mL
Urea	< 5 g per trial

### Safety First

Wear gloves and use caution when handling acids and bases.

**Wear your goggles!**

### Part I. Determining the Heat Capacity of the Calorimeter

1. Set up a hot plate and heat 200–300 mL of deionized water to boiling in a 400 mL beaker. You may need to refresh your water supply periodically to prevent the water from boiling away completely.
2. Put two Styrofoam coffee cups in a 250 mL beaker. Take the top Styrofoam cup from the calorimeter, and tare it on the balance.

Weigh out about 70 grams of room temperature deionized water into the calorimeter and record the mass of the water to the nearest thousandth of a gram; this value is your mass of the cool water,  $\text{mass}^{\text{cool water}}$ .

3. Place the cup back into the calorimeter set-up. Take a 4"×4" piece of cardboard, with the hole in the center, and place it on top of the coffee cups. Insert a thermometer through the hole.
4. Using the buret holder, gently clamp the thermometer and lower it into the cup so that the whole bulb is covered with water, but is not touching the bottom of the cup.

Avoid positioning the calorimeter too close to a hot plate so that the water inside the calorimeter remains cool.

5. Put 30 mL of room temperature deionized water in the 50 mL Erlenmeyer flask and record the mass of the water to the nearest thousandth of a gram in your notebook along with the corresponding flask label; this value is your mass of hot water,  $\text{mass}^{\text{hot water}}$ .

Repeat this process with your second 50 mL Erlenmeyer and set it aside for later.

### Safety First

Be careful when working with hot plate and boiling water. Always use beaker tongs to manipulate the beaker.

6. Place one of the 50 mL Erlenmeyer flasks containing 30 mL of water into the beaker of boiling water using a utility clamp to hold it in place.

Make sure that the water level in the flask is below the water level in the 400 mL beaker. Allow the flask of water to sit in the boiling water for 15 minutes in order for the temperature of water in the flask to equilibrate to about 100 °C.

7. After the 15 minutes, measure the temperature of the boiling water in the beaker with your second thermometer and record to the nearest 0.2 °C; this temperature is your initial temperature of the hot water,  $T_i^{\text{hot water}}$ .
8. Just before transferring the hot water in the flask to the calorimeter, measure the temperature of the water in the calorimeter and record to the nearest 0.2 °C; this temperature is your initial temperature of the cool water,  $T_i^{\text{cool water}}$ .

Next, remove the thermometer and cardboard top from the calorimeter. Using your clamp, grasp the flask containing the 30 mL of hot water near the top and quickly, but carefully, pour the hot water into the calorimeter. Be careful that no hot water on the outside of the Erlenmeyer flask drips into the calorimeter.

Once you have transferred the hot water to the calorimeter, you or your lab partner may begin repeating steps 6–7 with the second Erlenmeyer flask you prepared in step 5 to speed things up.

9. Replace the cardboard top on the calorimeter and insert the thermometer. Adjust the thermometer's height so that it is not touching the bottom or sides of the calorimeter, yet the water is covering the thermometer bulb.

Again, gently clamp the thermometer in the buret holder to keep the thermometer stationary.

10. Gently swirl the water in the calorimeter around the now stationary thermometer until the highest temperature is reached. This is the equilibrium temperature. Watch the thermometer closely as it rises.
11. To prevent temperature fluctuations, swirl the water in the calorimeter to evenly distribute the heat. Monitor the temperature and record the highest temperature attained to the nearest 0.2 °C; this temperature is your final temperature,  $T_f$ .
12. While you are waiting for your second Erlenmeyer to reach about 100 °C, repeat steps 2–4. Once the water in the flask has equilibrated, complete steps 8–10.
13. Repeat this whole procedure 1 more time, to finish with 3 total trials.



## Part II. Determining the Specific Heat of a Metal

Using the same calorimeter for which you determined the heat capacity, you will analyze an unknown metal sample to find its characteristic specific heat and identify the sample as lead, aluminum or copper.

1. Continue boiling 200–300 mL of deionized water in a 400 mL beaker using a hotplate. Again, you may need to refresh your water supply to prevent the water from boiling away completely.
2. Set up your calorimeter by placing the two Styrofoam cups in a 250 mL beaker as before. Take the top Styrofoam cup from the calorimeter, place it on the balance and tare it.

Weigh out about 70 grams of room temperature deionized water into the calorimeter and record the mass of the water to the nearest thousandth of a gram.

3. Place the cup back into the calorimeter set-up. Take your 4" × 4" piece of cardboard, with the hole in the center, and place it on top of the coffee cups. Insert a thermometer through the hole.
4. Using the buret holder, gently clamp the thermometer and lower it into the cup so that the whole bulb is covered with water but is not touching the bottom of the cup.
5. Obtain a sample of the unknown metal from the box at the front of the room. Identify the metal based on density and color and write down the type of metal you obtained in your laboratory manual.

The sample should be a piece of metal strung with nylon string. Do not remove the nylon string. Weigh the unknown metal sample using a tared weigh boat to protect it from contamination. Record the mass of the metal to the nearest thousandth of a gram.

6. Attach a utility clamp to the bench top rod and hang the metal's string from the clamp to submerge, but suspend, the metal in the 400 mL beaker of boiling water. Suspending the metal ensure it equilibrates with the temperature of the boiling water by preventing direct heating by hot plate (which will occur if the metal rests on the bottom of the beaker). Add more water to the beaker if necessary and return to a boil.
7. Suspend the metal in the boiling water for 3–4 minutes, to ensure the metal's temperature is approximately 100 °C.
8. After the 3–4 minutes, measure the temperature of the boiling water in the beaker with your second thermometer and record to the nearest 0.2 °C; this temperature is your initial temperature of the metal,  $T_i^{\text{metal}}$ .

### Safety First

To avoid burns, use crucible tongs to pick up hot metal. Never pick up a heated metal with your bare hands.

Be careful not to drop the metal into the beaker.

9. Just before transferring the metal to the calorimeter, measure the temperature of the water in the calorimeter and record to the nearest 0.2 °C. This is the initial temperature of the water,  $T_i^{\text{water}}$ , and calorimeter,  $T_i^{\text{calorimeter}}$ .

Using the string, lift and shake the suspended metal vertically so that a maximum amount of hot water will drip off the metal surface. Quickly, but carefully drop the metal into the calorimeter and cover with the cardboard. Make sure that the metal sample is completely covered with water.

10. Replace the thermometer through the hole in the cardboard top on the calorimeter. Adjust the thermometer's height so that the water is covering the thermometer bulb without touching the metal or the Styrofoam cup.
11. Watch the thermometer rise until an equilibrium temperature (highest temperature) is reached. To prevent temperature fluctuations and evenly distribute the heat, try swirling the water in the calorimeter without breaking the thermometer on the metal.

Monitor the temperature and record the highest temperature attained to the nearest 0.2 °C; this temperature is your final temperature,  $T_f$ .

12. Repeat this procedure two more times using the same metal sample, but replace the water in the calorimeter each time. You should have 3 total trials.

### Part III. Calculating the Enthalpy of an Endothermic Reaction

The cold packs in some first-aid kits are made of urea pellets encased in a plastic bag surrounded by water. When the cold pack is bent, the inner bag is broken and an endothermic reaction occurs as the urea dissolves in the water. As a result, the pack gets colder. You will be simulating this reaction in your calorimeter in order to calculate the enthalpy of reaction,  $\Delta H_{\text{rxn}}$ , in J/mol.

1. Set up your calorimeter by placing the two Styrofoam cups in a 250 mL beaker as before. Take the top Styrofoam cup from the calorimeter, tare it on the balance. Weigh out about 25 grams of room temperature deionized water into the calorimeter and record the mass of the water to the nearest thousandth of a gram.
2. Place the cup back into the calorimeter set-up. Take your 4" × 4" piece of cardboard, with the hole in the center, and place it on top of the coffee cups. Insert a thermometer through the hole.
3. Using the buret holder, gently clamp the thermometer and lower it into the cup so that the whole bulb is covered with water, but is not touching the bottom of the cup.

4. Tare a clean weigh boat and weigh out about 4–6 grams of urea. Record the mass of the urea to the nearest thousandth of a gram.
5. Just before transferring the urea to the calorimeter, measure the temperature of the water in the calorimeter and record to the nearest 0.2 °C. This is the initial temperature of the water,  $T_i^{\text{water}}$ , and calorimeter,  $T_i^{\text{calorimeter}}$ .

Next, remove the thermometer and cardboard top from the calorimeter. Carefully, add the urea to the calorimeter and cover with the cardboard. Make sure that none of the urea or water spills out of the calorimeter.

6. Replace the thermometer through the hole in the cardboard on top of the calorimeter, and adjust its height so the bulb is covered without touching the bottom or sides of the calorimeter.
7. Gently swirl the water in the calorimeter around the now stationary thermometer until the urea is dissolved and the solution achieves a uniform temperature throughout the calorimeter. Monitor the temperature and record the lowest temperature attained to the nearest 0.2 °C; this temperature is your final temperature,  $T_f$ .
8. Repeat this procedure two more times to finish with 3 total trials. Clean the calorimeter and thermometer between trials.

**Clean-Up:**

- All solutions may be disposed of by washing down the sink with copious amounts of water. Be sure to rinse out the calorimeter before returning it at the front of the room.

## Part IV. Calculating the Enthalpy of Exothermic Reactions

Neutralization reactions are exothermic reactions. You will be measuring quantities to estimate the enthalpy change for the neutralization of hydrochloric acid with sodium hydroxide. The number you will calculate is not, strictly speaking, the enthalpy of reaction of hydrochloric acid and sodium hydroxide. The heat released by diluting the acid and the base is also included in that number.

### Safety First

Do not put your hands or arms on the edges of the fume hood.

There may be spills of acids/chemicals which are not visible.

1. Solution preparation:
  - a. Prepare 60 mL of 2.0 M sodium hydroxide from 6.0 M sodium hydroxide stock solution.
  - b. Dispense no more than 25 mL of 6.0 M hydrochloric acid into a 100 mL beaker.
2. Calorimeter set-up:
  - a. Clean your Styrofoam cups and set up your calorimeter by placing the two Styrofoam cups in a 250 mL beaker as usual. Take your 4"×4" piece of cardboard, with the hole in the center, and place it on top of the coffee cups. Insert a thermometer through the hole. Do not add water to your calorimeter.
  - b. Using the buret holder, gently clamp the thermometer and lower it into the cup so that the bulb is near but not touching the bottom of the cup.
3. Adding reagents to the calorimeter:
  - a. Transfer approximately 20 mL of 2.0 M sodium hydroxide solution you've prepared in a clean graduated cylinder. Record the volume to the nearest 0.2 mL.
  - b. Lift the cardboard top from the calorimeter and carefully transfer the sodium hydroxide from the graduated cylinder to the calorimeter.
  - c. Thoroughly clean your graduated cylinder and then carefully measure out about 8 mL of 6.0 M hydrochloric acid from your 100 mL beaker using a clean graduated cylinder. Record the volume to the nearest 0.2 mL.
  - d. Measure the temperature of the sodium hydroxide in the calorimeter and record to the nearest 0.2 °C. This is the initial temperature of the water,  $T_i^{\text{water}}$ , and calorimeter,  $T_i^{\text{calorimeter}}$ .
  - e. Carefully, add the hydrochloric acid to the calorimeter and cover with the cardboard. Make sure that none of the sodium hydroxide or hydrochloric acid spills out of the calorimeter. Adjust the thermometer's height, if needed, so that it is not touching the bottom or sides of the calorimeter yet the solution is covering the thermometer bulb.

- f. Gently swirl the solution in the calorimeter to achieve a uniform temperature throughout the calorimeter. Monitor the temperature and record the highest temperature attained to the nearest 0.2 °C; this temperature is your final temperature,  $T_f$ .
  - g. When your first trial is complete, pour the solution in your calorimeter into one 800 mL beaker. Save this solution.
4. Repeat the above procedure two more times to finish with 3 total trials.

### Green Chem

Don't throw away the styrofoam cups! Return them to your TA at the end of the lab.

#### Clean up:

- Slowly and carefully add 2 g of sodium bicarbonate to the 800 mL beaker containing all the used solutions from this part of the experiment.
- When the sodium bicarbonate is fully dissolved, pour this solution down the sink with copious amounts of water.

### Part V. Calculating the Heat of Fusion of Water

In this part of the experiment you will design an experiment to determine the heat of fusion of ice,  $\Delta H_{\text{fus}}$ . You will need your calorimeter, ice, water, and a balance. You may use any of the equipment in your locker. Be sure your method is repeatable. See how close you can come to the known result.

1. Design an experiment to determine the heat of fusion of ice. **You should come to the laboratory with an outline of the procedure you plan to use.**

**Note:** If you measure the mass of ice by placing it directly on a balance, it may melt and your mass measurement will be inaccurate. Think of a way to determine the mass of ice without directly adding it to the balance.

2. Complete the experiment by performing three separate trials. Write down the detailed procedure you used.

#### Clean-Up:

- All solutions may be disposed of by washing down the sink with copious amounts of water. Be sure to rinse out the calorimeter before returning it at the front of the room.

## Data Analysis

---

### Part I. Determining the heat capacity of the coffee cup calorimeter

1. What was the mass, in grams, of hot water added to the calorimeter?
2. What was the initial temperature of hot water before adding it to the calorimeter?
3. What was the final temperature of water in the calorimeter after adding hot water?
4. Using the equation

$$q^{\text{hot water}} = (C_p^{\text{water}})(\text{mass}^{\text{hot water}})(T_{\text{final}} - T_{\text{initial}}^{\text{hot water}})$$

calculate the heat lost by the hot water. Is this quantity positive or negative? The specific heat of water,  $C_p^{\text{water}}$ , is 4.184 J/g·°C.

5. What was the mass, in grams, of cold water in the calorimeter?
6. What was the initial temperature of cold water before adding the hot water to the calorimeter?
7. What was the final temperature of water in the calorimeter after adding hot water?
8. Using the equation

$$q^{\text{cool water}} = (C_p^{\text{water}})(\text{mass}^{\text{cool water}})(T_{\text{final}} - T_{\text{initial}}^{\text{cool water}})$$

calculate the heat gained by the cold water. Is this quantity positive or negative? The specific heat of water,  $C_p^{\text{water}}$ , is 4.184 J/g·°C.

9. When adding hot water to the calorimeter, heat is transferred to both the cold water and also the calorimeter itself. The heat lost by the hot water should be equal to the heat gained by the cold water and calorimeter combined. Using the equation

$$q^{\text{hot water}} = -(q^{\text{cool water}} + q^{\text{calorimeter}})$$

determine the amount of heat gained by the calorimeter. Is  $q^{\text{calorimeter}}$  a positive or negative quantity? Hint: Be careful with your negative values here. Remember that  $(-q^{\text{hot water}})$  has the opposite algebraic sign value of  $(q^{\text{hot water}})$ .

10. What was the initial temperature of the calorimeter before adding hot water? This should be the same initial temperature as the cold water.
11. What was the final temperature of the calorimeter after adding hot water? This should be the same final temperature as the water.
12. Using the equation

$$q^{\text{calorimeter}} = (C^{\text{calorimeter}})(T_{\text{final}} - T_{\text{initial}}^{\text{calorimeter}})$$

calculate the heat capacity of the calorimeter.

13. Repeat steps 1-12 for each of your trials.
14. Calculate the average heat capacity for the calorimeter.

- Calculate a standard deviation for the average heat capacity.
- Calculate a 90% confidence limit for this data.

## Part II. Determining the specific heat of a metal

- What was the mass, in grams, of cold water in the calorimeter?
- What was the initial temperature of cold water before adding the metal to the calorimeter?
- What was the final temperature of water in the calorimeter, after adding the metal?
- Using the equation

$$q^{cool\ water} = (C_p^{water})(mass^{cool\ water})(T_{final} - T_{initial}^{cool\ water})$$

calculate the heat gained by the cold water after adding the metal. Is this quantity positive or negative? The specific heat of water,  $C_p^{water}$ , is 4.184 J/g·°C.

- What was the initial temperature of the calorimeter before adding the metal? This should be the same initial temperature as the cold water.
- What was the final temperature of the calorimeter after adding the metal? This should be the same final temperature as the water.
- Using the equation

$$q^{calorimeter} = (C^{calorimeter})(T_{final} - T_{initial}^{calorimeter})$$

calculate the heat gained by the calorimeter after adding the metal. Is this quantity positive or negative?

- When adding the hot metal to the calorimeter, heat is transferred to both the cold water and also the calorimeter itself. The heat lost by the hot metal should be equal to the heat gained by the cold water and calorimeter combined. Using the equation

$$q^{metal} = -(q^{cool\ water} + q^{calorimeter})$$

determine the amount of heat lost by the hot metal. Is  $q^{metal}$  a positive or negative quantity?

- In grams, what was the mass of the metal?
- What was the initial temperature of the metal before adding it to the calorimeter? This should be the same initial temperature as the boiling water.
- What was the final temperature of the metal after adding it to the calorimeter? This should be the same final temperature as the water.
- Using the equation

$$q^{metal} = (C_p^{metal})(mass^{metal})(T_{final} - T_{initial}^{metal})$$

calculate the specific heat for your metal.

- Repeat steps 1-12 for each of your trials.

- Calculate the average specific heat for your metal sample.
- Calculate the standard deviation of your average specific heat.
- Using the physical properties of your metal, i.e. density & color, identify whether your metal is lead, aluminum, or copper.
- Calculate the percent error of your average specific heat as compared to the accepted value.

$$C_p^{Pb} = 0.128 \frac{J}{g \cdot ^\circ C} \quad C_p^{Al} = 0.900 \frac{J}{g \cdot ^\circ C} \quad C_p^{Cu} = 0.387 \frac{J}{g \cdot ^\circ C}$$

$$Relative\ Error = \frac{|experimental\ result - accepted\ value|}{accepted\ value} \times 100\ %$$

### **Part III. Calculating the enthalpy of an endothermic reaction**

- What was the mass, in grams, of water in the calorimeter?
- What was the initial temperature of water before adding the urea?
- What was the final temperature of water in the calorimeter after adding urea?
- Using the equation

$$q^{water} = (C_p^{water})(mass^{water})(T_{final} - T_{initial}^{water})$$

calculate the heat lost by the water. Is this quantity positive or negative? The specific heat of water,  $C_p^{water}$ , is 4.184 J/g·°C.

- What was the initial temperature of the calorimeter before adding the urea? This should be the same initial temperature as the water.
- What was the final temperature of the calorimeter after adding the urea? This should be the same final temperature as the water.
- Use the equation

$$q^{calorimeter} = (C^{calorimeter})(T_{final} - T_{initial}^{calorimeter})$$

calculate the heat lost by the calorimeter after adding the urea. Is this quantity positive or negative?

- The process of urea dissolving in water is an endothermic reaction. The "chemical system" in this situation, urea, absorbs heat from the surrounding environment. Using the equation

$$q_{rxn} = -(q^{water} + q^{calorimeter})$$

determine the amount of heat gained by the reaction (rxn). Is  $q_{rxn}$  a positive or negative quantity?

- Use the mass and molar mass of urea to calculate the number moles of urea dissolved.



10. The heat transfer in the calorimeter is taking place at constant pressure. Therefore, we can equate the heat gained by the chemical system of urea,  $q_{rxn}$ , to its enthalpy of reaction,  $\Delta H_{rxn}$ . Use the equation

$$\Delta H_{rxn} = \frac{q_{rxn}}{\text{moles } CO(NH_2)_2}$$

to calculate the enthalpy of the reaction per mole of urea in units of Joules per mole (J/mol).

11. Repeat steps 1-10 for each of your trials.
12. Calculate the average enthalpy of reaction,  $\Delta H_{rxn}$ , for the dissolution of urea in J/mol.
13. Calculate the standard deviation of the enthalpy of reaction.
14. Calculate a 90% confidence limit for this data.

#### Part IV. Calculating the enthalpy of an exothermic reaction

1. What is the combined mass, in grams, of sodium hydroxide and hydrochloric acid added to the calorimeter? Since the reaction of sodium hydroxide and hydrochloric acid forms sodium chloride (*aq*) and water (*l*), assume the density of liquid in the calorimeter to be 1.00 g/mL.
2. What was the initial temperature of sodium hydroxide before adding the hydrochloric acid?
3. What was the final temperature of water in the calorimeter after the reaction of sodium hydroxide and hydrochloric acid?
4. Using the equation

$$q^{water} = (C_p^{water})(mass^{water})(T_{final} - T_{initial}^{water})$$

calculate the heat gained by the water as a result of the exothermic reaction. Is this quantity positive or negative? The specific heat of water,  $C_p^{water}$ , is 4.184 J/g·°C.

5. What was the initial temperature of the calorimeter before adding the hydrochloric acid? This should be the same initial temperature as the sodium hydroxide.
6. What was the final temperature of the calorimeter after adding the hydrochloric acid? This should be the same final temperature as the water.
7. Using the equation

$$q^{calorimeter} = (C^{calorimeter})(T_{final} - T_{initial}^{calorimeter})$$

calculate the heat gained by the calorimeter as a result of the exothermic reaction. Is this quantity positive or negative?

8. The process of sodium hydroxide and hydrochloric acid reacting is an exothermic reaction. The "chemical system" in this situation, sodium hydroxide and hydrochloric acid, releases heat to the surrounding environment, water and the calorimeter. Using the equation

$$q_{rxn} = -(q^{water} + q^{calorimeter})$$

determine the amount of heat lost by the reaction. Is  $q_{rxn}$  a positive or negative quantity?

9. Calculate the number moles of hydrochloric acid used in the reaction for each trial.
10. The heat transfer in the calorimeter is taking place at constant pressure. Therefore, we can equate the heat lost by the chemical system,  $q_{rxn}$ , to its enthalpy of reaction,  $\Delta H_{rxn}$ . For each trial, calculate the enthalpy of the neutralization reaction per mole of hydrochloric acid in units of Joules per mole.
11. Repeat steps 1-10 for each of your trials.
12. Calculate the average enthalpy of reaction,  $\Delta H_{rxn}$  in J/mol.
13. Calculate the standard deviation of the enthalpy of reaction.
14. Calculate a 90% confidence limit for this data.

### Calculating the heat of fusion of water

1. What was the mass, in grams, of water in the calorimeter before adding ice?
2. What was the initial temperature of water before adding the ice to the calorimeter?
3. What was the final temperature of water in the calorimeter after adding the ice?
4. Using the equation

$$q^{water} = (C_p^{water})(mass^{water})(T_{final} - T_{initial}^{water})$$

calculate the heat lost by the water after adding the ice. Is this quantity positive or negative? The specific heat of water,  $C_p^{water}$ , is 4.184 J/g·°C.

5. What was the initial temperature of the calorimeter before adding the ice? This should be the same initial temperature as the water.
6. What was the final temperature of the calorimeter after adding the ice? This should be the same final temperature as the water.
7. Using the equation

$$q^{calorimeter} = (C^{calorimeter})(T_{final} - T_{initial}^{calorimeter})$$

calculate the heat lost by the calorimeter after adding the ice. Is this quantity positive or negative?

8. When adding the ice to the calorimeter, heat is transferred from both the water and the calorimeter to the ice. This increase in heat causes the ice to undergo "fusion", or melt. After the ice melts, the resulting water still contains less heat and is at a lower temperature than the original water and calorimeter. Therefore, the water from the ice will continue to gain heat

until it becomes the same temperature as the original water and the calorimeter. The change in heat during melting can be described as  $q^{ice}$ . The change in heat when the ice water equilibrates can be described as  $q^{ice\ water}$ . The heat gained by the ice during melting and ice water during heating is equal to the heat lost by the original water and calorimeter, so

$$q^{ice} + q^{ice\ water} = -(q^{water} + q^{calorimeter})$$

Using this equation, determine  $(q^{ice} + q^{ice\ water})$ .

- What is the mass of ice added to the calorimeter?
- $(q^{ice} + q^{ice\ water})$  can be further broken down mathematically. The heat gained by ice while melting can be described as

$$q^{ice} = (mass^{ice})(\Delta H_{fusion})$$

The heat gained by the ice water while equilibrating can be described as:

$$q^{ice\ water} = (C_p^{water})(mass^{ice\ water})(T_{final} - T_{initial}^{ice\ water})$$

As a result:

$$q^{ice} + q^{ice\ water} = (mass^{ice})(\Delta H_{fusion}) + (C_p^{water})(mass^{ice\ water})(T_{final} - T_{initial}^{ice\ water})$$

Use this equation to determine  $\Delta H_{fusion}$  for water. Assume the initial temperature of ice water is 0 °C.

- Use the following equation to calculate the heat of fusion per gram of ice:

$$\frac{\Delta H_{fusion}}{mass\ of\ ice\ in\ grams} = \Delta H_{fusion}\ per\ gram\ of\ ice$$

- Repeat steps 1-11 for each of your trials.
- Calculate the average heat of fusion per gram of ice.
- Calculate the standard deviation for the average.
- Calculate your percent error. The accepted value for the Heat of Fusion of ice, according to the textbook, is 330 J/g. Note that this value is reported here only to 2 significant figures.



# General Analytical Techniques

## Introduction

---

Analytical chemistry enables us to identify the constituents of unknown compounds and the relative amounts of these constituents. When we identify an unknown compound, we are performing a **qualitative analysis**. On the other hand, if we can numerically determine the amounts of constituents in an unknown sample, we are performing a **quantitative analysis**.

Suppose you were asked to determine what had caused a large fish kill in a lake or river. You would first attempt to determine what is in the water to see what could have caused the disaster. This is *qualitative* analysis. Then you would determine how much of the suspected toxin was present to determine if the concentration was high enough to cause the problem. This is *quantitative* analysis.

In the next few weeks, you will learn some of the techniques used in quantitative analysis. Quantitative analysis offers a numerical description of the amount of a constituent (the analyte) in a sample. One of the units we use to measure quantity is molarity—moles of analyte per liter of solution.

You should be aware that precise measurements are very important in quantitative analysis. When testing for toxicities, a thousandth of a gram can make the difference between a safe amount and one that is lethal. These measurements are often taken in parts per million, that is,  $1 \times 10^{-6}$  grams of analyte per 1 gram of sample!

## Experiment Overview

---

### Background

Over the next few weeks, you will have the opportunity to use two common analytical laboratory techniques.

One of the procedures you will perform involves volumetric analysis using titration methods. In a volumetric analysis, you measure the volume of solution that contains a sufficient amount of reagent to react completely with the analyte. In the volumetric analysis experiment, you will learn how to prepare aqueous solutions of a specific concentration using volumetric glassware, and perform titrations using graduated burets.

Another one of the procedures you will perform involves spectroscopic analysis, using a spectrophotometer. Using this method, you will learn how to prepare dilutions of a concentrated solution, and quantitatively measuring the concentration of an aqueous sample by measuring its absorbance.

Many of the experiments require you perform somewhat complex calculations before and after the lab session. If you have difficulty understanding the math, be sure to consult your TA before you complete the pre-lab exercises.

### Technique and Precision

Some of these quantitative analysis methods are more precise than others, but they will all be imprecise if your technique is poor. You will be taught the proper techniques in using the lab ware introduced in these experiments. Using the proper techniques will increase the accuracy of your measurements and reduce the likelihood of accidents. Learning the correct laboratory techniques is an integral part of the laboratory experience.

### Handling of Volumetric Glassware

Due to the high accuracy requirement for volumetric glassware, they are extremely expensive. Handle all volumetric glassware with great care to avoid breakage.

Before beginning the analytical experiments, you should first become acquainted with how to use volumetric glassware. You may find the information in the *Common Laboratory Techniques* section in the Appendix of this manual.

# Volumetric Analysis

## Introduction

---

In this experiment, you will prepare a few standard solutions. You will then use these standard solutions to determine the precise amount of the active ingredient in a few common household items using volumetric analytical techniques.

A standard solution of a reagent is one whose solute concentration is accurately known. If a solute can be obtained in a very pure, stable, weighable form, a primary standard solution of it can be prepared directly. To prepare a primary standard solution, an accurately determined amount of the solute must be dissolved in the desired solvent with an accurately known final volume. Care must be taken to ensure that the solution is homogeneous and that it is at ambient temperature when the final adjustment of its volume is made.

If the desired reagent cannot be obtained in primary standard form, one can only prepare a secondary standard solution of it. A secondary standard solution is prepared by dissolving an approximate amount of the solute in the desired solvent to the desired final volume, and standardizing the solution.

A reagent solution may be standardized in a few ways:

- 1) By titration against a measured mass of a suitable primary standard substance;
- 2) By titration against another reliably known secondary standard solution;
- 3) By direct analysis for the reagent in question by some suitable non-titrimetric method such as spectroscopic analysis.

In Part I of this experiment, you will prepare a solution of sodium hydroxide to determine the acetic acid content of a commercial vinegar solution through titration.

However, solid sodium hydroxide is hygroscopic (i.e. it attracts and holds water molecules from the surrounding environment), which makes it difficult to prepare a primary standard solution of sodium hydroxide. Therefore, you will prepare the sodium hydroxide solution as a *secondary standard*, and standardize it against a *primary standard*, Potassium Hydrogen Phthalate. Potassium Hydrogen Phthalate (abbreviated as “KHP,” also known as Potassium Acid Phthalate) is a monoprotic acid with the formula  $\text{KHC}_8\text{H}_4\text{O}_4$ .

Once you have accurately determined the concentration of your sodium hydroxide solution, you will use the standardized sodium hydroxide solution to determine the acetic acid content of a commercial vinegar solution in another set of replicate titrations.

In Part II of this experiment, you will prepare a solution of hydrochloric acid and standardize it against the sodium hydroxide solution you prepared in Part I. The standardized hydrochloric acid solution is referred to as a tertiary standard. You will use it to determine the neutralization capacity of commercial antacid tablets.

## Volumetric Analysis

Antacids work by neutralizing excess acid in your stomach. The active ingredient is usually carbonate ion ( $\text{CO}_3^{2-}$ ) or hydroxide ion ( $\text{OH}^-$ ). In this experiment, you will determine the mass and percentage of hydroxide or “equivalent hydroxide” that is present in the tablet, where one mole of carbonate is equivalent to the neutralizing capacity of two moles of hydroxide.

Because many antacids do not dissolve in water alone, before you analyze the antacid, you must dissolve the antacid sample in excess hydrochloric acid (your tertiary standard). Some, but not all, of the added hydrochloric acid will react with the base present in the tablet. You will then titrate the solution with sodium hydroxide (your secondary standard) to determine how much hydrochloric acid remained in excess.

You will then be able to calculate the amount of hydrochloric acid that reacted with the antacid by taking the difference between the amount of total hydrochloric acid added and the amount left in excess, and thus calculate the neutralization capacity of the antacid tablet. Using the calculated amount of hydrochloric acid that reacted with the antacid tablet, you may also determine the mass and percentage of hydroxide or “equivalent hydroxide” in the tablet.

This part of the experiment illustrates that analyses of “real life” unknowns are often complex and difficult.

### **Leaven: the tastiest acid/base reaction**

Leavened breads contain ingredients which cause them to rise while baking. Rising agents, or leaven, can be chemical or biological. Chemical rising is a result of an acid/base reaction between two ingredients. Baking soda usually serves as the base, while buttermilk, lemon juice, or yogurt can serve as the acid. This reaction forms carbon dioxide, which gets caught in the matrix of proteins in the dough and causes the dough to puff up.

Bread can also rise as a result of the biological activity of *Saccharomyces cerevisiae*, a.k.a. bakers yeast. Yeast consume carbohydrates in the dough in order to grow and divide, and then release carbon dioxide as a product of cellular respiration. An incomplete list of leavened and unleavened breads is given below. How many have you tried?

Leavened breads: challah, soda bread, naan, focaccia, sourdough, rye, frybread, bagels, brioche

Unleavened: chapati, tortillas, roti, lavash, matzah, arepas, kitcha



## Learning Goals

---

The following is a list of skills that you will use in this experiment.

<b>Laboratory</b>	<ul style="list-style-type: none"><li>• Preparing standards</li><li>• Weighing by difference</li><li>• Using a desiccator</li><li>• Conditioning, filling, and using a buret</li><li>• Performing a titration</li></ul>
<b>Conceptual</b>	<ul style="list-style-type: none"><li>• Stoichiometry</li><li>• Neutralization reactions</li><li>• Primary vs. secondary vs. tertiary standards</li></ul>
<b>Data Analysis</b>	<ul style="list-style-type: none"><li>• Calculating volume and mass of reagents used to prepare solutions</li><li>• Determining molarity of a titrated analyte</li></ul>

## Procedure

---

### Safety First

Wear goggles throughout the entire experiment.

Be especially careful with acids and bases.

Be careful when reading a buret, and be sure to always hold the buret beneath shoulder level when you are filling it.

This experiment will span 2 laboratory periods. Solutions prepared from the first period must be kept in your locker until you have completed the entire experiment. **Work in pairs**, but remember to learn and experience all the techniques introduced in this experiment.

The actual data analyses and the written reports must be done entirely independently of your lab partner or other students. Make sure that you avoid unauthorized collaboration and plagiarism. All suspected violations of the Code of Academic Conduct will be referred to Student Judicial Affairs.

### Stock Chemicals Used

Chemical	Maximum Amount Used
6 M Sodium Hydroxide	< 7 mL
6 M Hydrochloric Acid	<12 mL
Potassium Hydrogen Phthalate (KHP)	< 2 g
1% Phenolphthalein Indicator	Drops
Methyl Orange Xylene Cyanol FF	Drops
Commercial Vinegar	~ 20 mL

## PART I. ANALYSIS OF COMMERCIAL VINEGAR

### A. Preparing the Sodium Hydroxide Solution (Secondary Standard)

1. Prepare 400 mL of approximately 0.1 M sodium hydroxide solution by diluting commercial 6 M sodium hydroxide.

Calculate the volume of 6 M sodium hydroxide solution needed before you begin.

- a. Pour about 150 mL of DI water into a 250 or 500 mL Erlenmeyer flask.
- b. Transfer the appropriate volume of stock solution to a 10 mL graduated cylinder using a polyethylene transfer pipet. Estimate the volume of the sodium hydroxide and then quantitatively transfer the sodium hydroxide into the Erlenmeyer flask:
  - i. Pour the sodium hydroxide into the Erlenmeyer flask.
  - ii. Rinse the wall of the graduated cylinder with a wash bottle filled with DI water twice, and pour the rinse water into the Erlenmeyer flask each time.
- c. Carefully add enough DI water to the Erlenmeyer flask until the volume reaches 200 mL, then pour the solution into a 1L plastic bottle. Cap the bottle and mix the contents thoroughly by inverting the bottle and swirling it repeatedly. Then, add the remaining 200

mL of water and again, mix the bottle contents thoroughly. The bottle should be shaken at least 50 times total.

## B. Standardizing the Sodium Hydroxide Against Potassium Hydrogen Phthalate

In this step of the experiment you will standardize your sodium hydroxide solution against the primary standard, potassium acid phthalate. You will also use a technique called **weighing by difference**.

### Weighing By Difference

---

This technique eliminates systematic errors from the balance during weighing.

- First, measure the mass of the container with the material from which you are going to draw your sample.
  - Then, remove some of the material and place it in a separate container.
  - Re-measure the mass of the original container and the remaining material.
  - Calculate the mass removed, and repeat the process until you have removed the mass desired.
- 

**Question A:** Explain how weighing by difference eliminates systematic balance errors.

2. Prepare the analyte flask by transferring 3 samples of your primary standard (KHP) into 3 different containers using the following guidelines:
  - a. Using a folded paper strip to handle the vial, accurately weigh a 0.25–0.35 gram sample of dry KHP onto a weighing boat.
  - b. Using the appearance of the first weighed sample as a guide, accurately transfer two to three more samples of dry KHP into clean 125, 250, or 500 mL Erlenmeyer flasks through weighing by difference.
  - c. Quantitatively transfer the first weighed sample into a clean 125, 250, or 500 mL Erlenmeyer flask using a small amount of DI water from a wash bottle.
  - d. Add about 30 mL of DI water to each of the three flasks and swirl them gently until the solids dissolve. Use a wash bottle to rinse any solids or liquid on the sides of the flasks into the solution.

### Hint

---

Using a Kimwipe or paper towel to handle the vial will keep oils from your hands and matter on your gloves from changing the mass of the vial.

### Safety First

---

Always take the buret off the clamp and fill it from below shoulder level to avoid any splashes on your face.

3. Prepare the titrant by loading your dilute sodium hydroxide solution into the buret:
  - a. Understand how to fill and use a buret by reading the *Common Laboratory Procedures* section in the Appendix of this manual. Failure to properly fill the buret properly can result in spills and injuries.
  - b. Use a small beaker to condition and fill a 25 mL buret with the sodium hydroxide solution you wish to standardize. You may find the buret usage tips below to be helpful.
  - c. Estimate the buret reading to the nearest 0.02 mL (i.e. 1.02 mL or 0.34 mL) and record it in your notebook.

### Buret Usage Tips

---

- **Do not waste time trying to hit 0.00 with the meniscus.** Fill the buret to slightly below the zero mark and read and record the actual starting point to the nearest 0.02 mL.
  - Be sure always to wipe off the tip of a buret before you begin a titration. Use a laboratory tissue and make one quick stroke downward beginning at the stopcock and ending in the air beyond the buret tip.
- 

4. Perform the first titration. The first titration is a cursory one used to find the approximate volume of the end point.

The end point is reached in this titration when the analyte solution color becomes a persistent faint pink.

If the solution becomes very pink, you have overshot the end point. Don't worry if you have overshot the endpoint, because you have the materials to perform an additional titration to compensate.

- a. Add three drops of phenolphthalein indicator to the first KHP solution.
- b. Place the flask under the buret and lower the buret tip until it is inside the flask. Estimate and record in your notebook the initial buret reading.
- c. Add the sodium hydroxide titrant 1 mL at a time until the solution in the flask turns a persistent faint pink color. The solution should be stirred continuously during the titration.
- d. Once the end point is reached, estimate the final buret reading and record it in your notebook. Subtract the initial buret reading from the final buret reading. This is the volume of titrant used in this titration.
- e. Pour the solution in the Erlenmeyer flask into one 800 mL beaker.

5. Perform the second titration. This time, you should be more careful to find the end point accurately.
  - a. Refill your buret and record the initial buret reading.
  - b. Open the stopcock somewhat and allow a gentle but steady stream of base to flow (without splashing) into the pooled acid solution. You can add the base fairly rapidly at first, but pay attention to the region where the two solutions mix in the flask. Slow down as the pink color begins to tail out into the solution when you stir the contents of the flask. Stop adding the base when you are within 2 mL of the approximate endpoint.
  - c. Once you are within 2 mL of the approximate end point, gently wash down the walls of the flask with water from your wash bottle, and slowly add the titrant from the buret into the flask dropwise. As you approach the endpoint, the pink color will increasingly linger. You should frequently wash down the interior sides of the flask to recover any reagent drops from clinging to the sides. Swirl the flask after the addition of each drop. Stop adding base when the entire flask has a faint pink color that persists.
  - d. You may wish to record the buret volume reading of several successive drops as you approach the endpoint in case you discover that you have overshot the endpoint. Estimate the final buret reading to the nearest 0.02 mL and record it in your notebook.
  - e. Pour the solution in the Erlenmeyer flask into your 800 mL beaker.
6. Complete the remaining titrations of your KHP samples. Afterwards, pour all the solution in the Erlenmeyer flasks into your 800 mL beaker.
7. Calculate the concentration of your sodium hydroxide solution.
  - a. It should be clear to you that the ratio of the NaOH titration volume to the mass of KHP being titrated should be a constant. Calculate this ratio for your three titrations and determine if one of them fails the Q-test. If it does, run another sample.
  - b. When you have three replicate titration result data that can be retained, calculate and report the average molarity of the NaOH solution, the standard deviation of the average molarity, and the 90% confidence limit for the reported molarity. Refer to the Statistical Treatment of Data section in the Appendix of this manual if you need a refresher.

---

**Safety First**

Always take the buret off the clamp and fill it from below shoulder level to avoid any splashes on your face.

---

**Hint**

Potassium Hydrogen Phthalate (KHP) has the chemical formula of  $\text{KHC}_8\text{H}_4\text{O}_4$ , with a formula mass of 204.23.

**Question B:** Why doesn't it matter how much water you add when dissolving the acid or when carrying out the titration?

### C. Analysis of the Acetic Acid Content of a Commercial Vinegar

8. Prepare 3 samples of the same commercial vinegar for titration:
  - a. Obtain approximately 10 mL of a commercial vinegar solution in a clean 50 mL Erlenmeyer flask. Record the brand name and type.
  - b. Pipet 2.00 mL samples of vinegar into each of three clean 125, 250, or 500 mL Erlenmeyer flasks.
  - c. Wash down the sides of the flasks with another 25 mL or so of water from your wash bottle.
9. Using the same procedure as part B of the experiment, titrate the vinegar solution with your secondary standard as the titrant:
  - a. Add three drops of phenolphthalein indicator to the titration flask.
  - b. Titrate the analyte with your standardized NaOH solution. Ideally, the range of the replicate titration volumes should be only one or two drops. One drop from these burets is about 0.05 mL, so two “5 mL” titration volumes that differ by 2 drops disagree with each other by 1%.
  - c. Repeat the titration with the remaining vinegar samples.
10. Calculate and report the average titratable acid concentration,  $[\text{HC}_2\text{H}_3\text{O}_2]$ , in the commercial vinegar solution, and the 90% confidence limit for this result. Also calculate and report your average value for the mass percentage of acetic acid in the vinegar solution, along with the 90% confidence limit for this result.

#### Tip

Try using the titration thief method for at least the first titration.

#### Hint

Assume a density of 1.00 g/mL for the vinegar solution.

- **Save your remaining NaOH for Part II of this experiment!  
Perform all calculations before your lab next week!**

#### Clean-up.

- After Part I of the experiment is completed, drain any remaining solution from the buret and the flasks into one 800 mL beaker.
- Dissolve the remaining KHP in the solution in the 800 mL beaker.
- Rinse the buret with deionized water and pour the solution into the beaker. Then, leaving the stopcock open, return the inverted burets to the buret storage bucket.
- To your 800 mL beaker, add approximately 1 gram of sodium bicarbonate. Dispose of the solution in the 800 mL beaker in the lab sink.

## Data Analysis: Part I. Analysis of Commercial Vinegar

---

### Preparing the Sodium Hydroxide Solution (secondary standard)

1. Consider a 400 mL solution of 0.1 M NaOH. Calculate the volume of 6 M NaOH required to achieve this solution. Report your answer to 2 significant figures.
2. The density of 0.1 M NaOH at 20 °C is 1.01 g/mL. Calculate the percent by weight of NaOH in 400 mL of a 0.1 M NaOH solution. Report your answer to three significant figures.

### Standardizing the Sodium Hydroxide Against Potassium Hydrogen Phthalate

1. For each of your 3 acceptable trials (not the cursory one), what is the mass of KHP for each of the three samples? Report these masses to one thousandth of a gram, e.g. 0.507 g.
2. Using the masses of KHP above, determine how many moles of KHP were present in each sample.
  - Tip: KHP has the chemical formula  $\text{KHC}_8\text{H}_4\text{O}_4$ , with a formula mass of 204.23 g/mol.
3. For each of your 3 trials, what is the volume in mL of NaOH required to neutralize each KHP sample? Report these volumes to a hundredth of a mL, e.g. 15.24 mL.
4. Write down the chemical equation for the neutralization reaction of NaOH with KHP. Determine the stoichiometric ratio between these two reagents. In other words, how many moles of NaOH react with each mole of KHP?
5. Using the moles of KHP in each sample, stoichiometric ratio between KHP and NaOH, and volume of NaOH dispensed, calculate the molarity of your NaOH solution for each trial. When reporting data, make sure your values are reported in the same order as the masses of KHP and the volumes of NaOH required for each trial.
6. Calculate the average molarity of your NaOH solution.
7. Calculate the standard deviation of the molarities of your NaOH solution.
8. Calculate the 90% confidence limit for the average molarity of your NaOH solution.

### Analysis of the Acetic Acid Content of a Commercial Vinegar

1. For each of your 3 acceptable trials, what is the volume of vinegar for each of the three samples? Report these volumes to one hundredth of a mL, e.g. 2.04 mL.
2. For each of your 3 trials, what is the volume of NaOH required to reach the endpoint? Report these volumes to one hundredth of a mL, e.g. 8.50 mL.
3. Write down the chemical equation for the neutralization reaction of NaOH with acetic acid. Determine the stoichiometric ratio between these two reagents. In other words, how many moles of NaOH react with each mole of acetic acid?

## Volumetric Analysis

4. Using the average molarity of your NaOH solution, the volume of NaOH dispensed, the stoichiometric ratio between NaOH and acetic acid, and the volume of vinegar, calculate the molarity of acetic acid in all 3 of your vinegar samples.
5. Calculate the average molarity of acetic acid in your commercial vinegar solution.
6. Calculate the standard deviation of the molarities of acetic acid.
7. Calculate the 90% confidence limit for the average molarity of acetic acid.



## PART II. NEUTRALIZATION CAPACITY OF ANTACID TABLETS

### A. Preparing the Standard Hydrochloric Acid Solution (Tertiary Standard)

In this procedure you will prepare a tertiary standard (a dilute HCl solution), to be standardized against the secondary standard NaOH solution you prepared in part I last week.

1. Begin the standardization procedure by preparing 150 mL of  $\sim 0.4$  M HCl from a 6.0 M stock solution in a 250 mL beaker.
  - a. Calculate the volume of 6.0 M HCl and DI water needed.
  - b. Place about 80% of the required deionized water into the 250 mL beaker.
  - c. Estimate the volume of 6.0 M HCl using a graduated cylinder before you quantitatively transfer this volume to the beaker.
  - d. Add sufficient quantity of DI water to the 150 mL mark on the beaker and stir the solution with your glass stir rod. You have now successfully prepared the standard acid solution.

**Question C:** You always add acid to water, and never the reverse. Why?

### B. Standardizing the Acid Against Sodium Hydroxide

2. In this procedure, titrate the HCl solution you just prepared against your standardized sodium hydroxide solution, using a procedure similar to the analysis of commercial vinegar.
  - a. Add approximately 20 mL of deionized water to a clean 125, 250, or 500 mL Erlenmeyer flask and then accurately transfer 5.00 mL of your prepared standard acid solution using a clean volumetric pipet to the same Erlenmeyer flask. Prepare 3 or 4 samples using your other Erlenmeyer flasks.
  - b. Rinse and fill a 25 mL buret with your standard NaOH solution. Estimate the initial volume reading and record it in your notebook.
  - c. Add 3 drops of phenolphthalein indicator to the flask and carefully titrate to the end point (a persistent faint pink). Estimate the final buret reading and record it in your notebook.
  - d. Repeat this titration at least 2 more times.
3. Calculate the actual concentration of your hydrochloric acid solution using the concentration of base you determined in Part I for each trial. Calculate and report the average concentration of your acid, the standard deviation of the average concentration, and the 90% confidence limit for the reported concentration.

### C. Antacid Analysis

In this part of the experiment, perform at least 3 titrations with crushed samples from one brand of commercial antacid tablets.

4. Sample preparation of the antacids requires that you add enough dilute HCl to completely neutralize all carbonate ions in the antacid. This is done to ensure that all the carbonate ions are dissolved in the analyte solution. Do NOT over acidify!
5. Measure the mass of 3 tablets from the brand of commercial antacids assigned to your group. Record the masses of these whole tablets along with the brand name.
6. Crush 3 antacid tablets using the mortar and pestle for that commercial brand. Suggested mass to be used for each trial of analysis is indicated on the lids of the antacid containers.

Record the mass of the crushed sample for each trial. Quantitatively transfer the sample to a clean 125, 250, or 500 mL Erlenmeyer flask.

7. Add approximately 25 mL of deionized water to the flask and then carefully and accurately dispense 14 mL of your standardized hydrochloric acid into the flask using a buret. Estimate the initial and final volume of acid dispensed into the flask and record it in your notebook.
8. Clamp the flask securely and heat the contents with a hot plate. Boil the solution for 5 minutes. The sample may not completely dissolve during this process due to the presence of “fillers,” but any base will have reacted with the excess HCl.
  - a. Using your alkacid paper, check to be sure that all base has reacted, and that there is excess acid present.
  - b. If the solution is not acidic, then accurately add another 1 mL of acid, estimate the buret reading and record the volume dispensed, and boil the solution for another 5 minutes. Repeat this process if needed. Do NOT over acidify the sample!
  - c. Cool the solution to room temperature by carefully immersing the flask in a container of tap water.
  - d. Repeat with the remaining samples.
9. Perform the first titration in this analysis with sodium hydroxide standard solution.
  - a. Add 5 drops of methyl orange/xylene cyanol FF indicator (MOXC) to the solution. Titrate the sample with your NaOH standard.
  - b. The indicator MOXC goes from red (acidic), through grey, to green (basic). The grey color is the end point. The end point is not as

- obvious as that of phenolphthalein. If you add too much base, you will need to back-titrate with your HCl standard.
- c. To back-titrate your sample, add a carefully measured volume of your HCl standard to return the solution to the red color. Then titrate again to the grey end point using your NaOH standard.
  - d. Once the end point is reached, estimate the final buret reading, and then add 1 mL of NaOH until the solution is green.
10. Repeat the titration twice more using the suggested mass on the antacid container. Make sure you have three good trials before going on to the next step.
11. Calculate the following:
- a. Report the neutralization capacity (millimoles of HCl neutralized) of the antacid tablet you used. Calculate the mass and mass percentage of hydroxide or “equivalent hydroxide” per gram of antacid tablet.
  - b. Calculate an average, standard deviation, and 90% confidence limit of your data. Report the results in your notebook. Be sure to show all calculations.

**Question D:** Write a balanced chemical equation that describes the reaction if the antacid contains hydroxide ion.

**Question E:** Write a balanced chemical equation that describes the reaction if the antacid contains carbonate ion.

**Clean-Up:**

- Combine your analyte solution from the titration of antacids in Part C, and any left-over antacid samples in the 1 L bottle containing NaOH.
- **Slowly** add your standardized HCl solution to the 1 L bottle.
- Use an alkacid paper strip to test the pH of the solution. If it is acidic, slowly add sodium bicarbonate to the bottle until fizzing can no longer be observed.
- Pour the neutralized solution down the drain with copious amount of water.
- Rinse the 1 L bottles with water.
- Rinse the buret with DI water. Then, leaving the stopcock open, return the inverted burets to the buret storage bucket.

## Data Analysis: Part II. Neutralization Capacity of Antacid Tablets

---

### Preparing the Standard Hydrochloric Acid Solution (Tertiary Standard)

1. Consider a 150 mL solution of 0.4 M HCl. Calculate the volume of 6 M HCl required to achieve this solution. Report your answer to 2 significant figures.

### Standardizing the Acid Against Sodium Hydroxide

1. For each of your 3 trials, what is the volume (in mL) of each HCl sample? Your volume of HCl should be approximately 5 mL. Report these volumes to a hundredth of a mL, e.g. 15.24 mL.
2. For each of your 3 trials, what is the volume (in mL) of standardized NaOH required to neutralize each HCl sample? Report these volumes to a hundredth of a mL, e.g. 15.24 mL.
3. Write down the chemical equation for the neutralization reaction of NaOH with HCl. Determine the stoichiometric ratio between these two reagents. In other words, how many moles of NaOH react with each mole of HCl?
4. Using the average molarity of your standardized NaOH solution, the volume of NaOH dispensed, the stoichiometric ratio between NaOH and HCl, and the volume of HCl solution, calculate the molarity of HCl in all 3 of your samples.
5. Calculate the average molarity of your HCl solution.
6. Calculate the standard deviation of the molarities of your HCl solution.
7. Calculate the 90% confidence limit for the average molarity of HCl solution.

### Antacid Analysis

1. You measured the mass of 3 antacid tablets. What is the average mass of 1 antacid tablet? Report these masses to one thousandth of a gram, e.g. 0.507 g.
2. For each trial, what is the mass of crushed antacid tablet dissolved with HCl? Report these masses to one thousandth of a gram, e.g. 0.507 g.
3. For each trial, what volume of standardized HCl did you use to dissolve the samples? Make sure to report the total volume of acid that you used to dissolve the samples, including any additions of acid after the first one needed to make the solution acidic, to the nearest 0.02 mL.
4. Using the concentration of standardized HCl and the total volume of HCl used to dissolve the antacid sample, calculate the total number of moles of HCl added to the antacid sample for each trial.
5. For each trial, what was the volume (in mL) of standardized NaOH required to titrate the residual HCl after it reacted with the antacid? Report these volumes to the nearest 0.02 mL.
6. Using the concentration of standardized NaOH, the volume of NaOH used to neutralize the HCl solution, and the stoichiometric ratio of HCl reacting with NaOH, determine the number of moles of HCl neutralized by NaOH for each trial.

7. Using the total number of moles of HCl added to the antacid sample (step 4), and the number of moles of HCl neutralized by NaOH (step 6), determine the number of moles of HCl used to directly neutralize the antacid sample in each trial. Convert this value to millimoles.
8. Using the number of millimoles of HCl used to neutralize the antacid sample and the mass of the antacid sample in mg, calculate the MILLIMOLES of HCl reacted per MILLIGRAM of sample for each trial. These final values should have the units mmol/mg.
9. Using the calculated millimoles HCl/mg sample (step 8) and the average mass of the antacid tablet in milligrams, calculate the average millimoles of HCl neutralized per tablet for each of your three trials.
10. Using the calculated millimoles HCl/mg sample (step 8), the stoichiometric ratio of HCl reacting with NaOH, and the molar mass of the hydroxide ion ( $\text{OH}^-$ ), report the gram equivalent  $\text{OH}^-$  per gram of antacid for each of your three trials. These final values should have the units g/g.
11. Convert the gram equivalent  $\text{OH}^-$ /gram antacid to % equivalent  $\text{OH}^-$  for each of your trials. These final values should have the unit %.
12. Calculate the average % equivalent  $\text{OH}^-$  of the three trials.
13. Calculate the standard deviation of % equivalent  $\text{OH}^-$ .
14. Calculate the 90% confidence limit for the average % equivalent  $\text{OH}^-$ .



# Reactions of Copper

## Introduction

---

In this experiment, you will do a series of reactions with the element copper. These reactions will involve the use of some new techniques and some interesting color changes. In addition, they will illustrate some of the classes of chemical reactions that occur in nature, for example, oxidation-reduction reaction. It is important that you make careful observations as you carry out these procedures. It is also very important that you attempt to answer the questions as they appear in the procedures. This will keep you from falling into the trap of the cookbook approach that was discussed earlier and help you more fully understand the principles involved in the experiment.

In the first reaction you will dissolve elemental copper and make a solution of copper nitrate. This solution will then be treated with a base that causes a precipitation. The resulting precipitate will then be heated to produce an oxide of copper. The oxide will then be treated with sulfuric acid to produce a blue colored solution of copper(II) sulfate. Finally, the copper ion will be reduced by zinc to produce copper metal that you will collect and dry.

In some steps of this experiment you are given amounts of chemicals to use so that you have an idea of the scale at which you should work. In other steps you are left to make your own decisions.

### **Ceramics: at the intersection of art and chemistry**

Ceramics is one of the most ancient art forms in the world. It involves making items from clay, and then heating, or "firing", the clay at high temperatures in a kiln oven. Oftentimes ceramic goods are covered in a special coating called "glaze" which adds color and texture, and may make the piece impervious to water.

Copper compounds are used as a colorant in many glazes. For example, copper carbonate ( $\text{CuCO}_3$ ) and copper oxide ( $\text{CuO}$ ) can be used to produce shades of green, turquoise, or even red. The color of the glaze after firing depends on what other compounds are present in the glaze, and whether the ceramics are fired under an oxidative or reductive atmosphere. A reductive atmosphere is created when air is prevented from entering the kiln or fuel is added in excess. This reduces the amount of oxygen available to react with the glaze and clay. An oxidative atmosphere is created using the opposite conditions, when a lot of air is allowed to enter the kiln or a minimum amount of fuel is added.

## Learning Goals

---

The following is a list of skills that you will use in this experiment.

<b>Laboratory</b>	<ul style="list-style-type: none"><li>• Using the fume hood</li><li>• Using a hot plate</li><li>• Decanting liquid</li><li>• Quantitative transfer</li><li>• Using a casserole dish</li></ul>
<b>Conceptual</b>	<ul style="list-style-type: none"><li>• Oxidation-reduction reactions</li><li>• Single replacement reactions</li><li>• Double replacement reactions</li><li>• Precipitation reactions</li></ul>
<b>Data Analysis</b>	<ul style="list-style-type: none"><li>• Balancing chemical equations</li><li>• Identifying oxidized and reduced elements</li><li>• Calculating percent yield</li></ul>



## Procedure

---

**Work in pairs** on this experiment.

The actual data analyses and the written reports must be done entirely independently of your lab partner or other students. Make sure that you avoid unauthorized collaboration and plagiarism. All suspected violations of the Code of Academic Conduct will be referred to Student Judicial Affairs.

### Stock Chemicals Used

Chemical	Maximum Amount Used
6 M Hydrochloric Acid	10 mL
6 M Nitric Acid	~10 mL
3 M Sulfuric Acid	~10 mL
6 M Sodium Hydroxide	10–20 mL
Copper Wire	0.5 g
Granular Zinc, 20 mesh	~ 0.5 g
Conc. Nitric Acid (15 M)	~ 4 mL

### Safety First

Carry out all steps that produce fumes in the hoods as described.

Be especially careful when handling acids and bases.

Wear your goggles.

### A. Making a Solution of Copper(II) Nitrate

1. Acquire a piece of copper wire from your TA. Accurately measure its mass on an analytical balance to the nearest 0.001 gram. It should be approximately 0.5 gram. Using your pencil or pen, coil the wire into a flat spiral and place it into a clean 150 mL beaker.
2. Measure 4 mL of concentrated nitric acid found in the **fume hood** into a graduated cylinder using a disposable pipet. Bring your beaker containing copper wire to the hood. **With both the beaker and graduated cylinder in the hood**, pour the nitric acid into the beaker containing the copper wire.

Make observations regarding any changes that occur during the reaction. Be careful not to breathe any of the fumes! Make notes of your observations in your notebook.

3. Swirl the beaker to be sure all the copper dissolves. If all the copper fails to dissolve within 10 minutes, add 1 additional mL of nitric acid. Do not add more than 5 mL of nitric acid in total. Once all the copper solid has dissolved, proceed to the next step.
4. Fill your wash bottle with DI water, and carefully rinse the sides of your graduated cylinder with a small amount of DI water from the wash bottle. Pour this rinse water into the 150 mL beaker containing copper. Slowly add more DI water to the beaker until the volume of solution reaches 30 mL.

### Hint

Do not use 6 M nitric acid for this step!

Be sure that **no more fumes are being created** before you remove the beaker from the fume hood. Be patient, as this process can take 10 minutes or more.

**Question A:** This reaction is an oxidation-reduction reaction that is somewhat complicated:



Identify the elements oxidized and reduced in this reaction and indicate how many moles of electrons are transferred between the elements being oxidized and reduced.

### B. Synthesis of solid copper(II) hydroxide

The second reaction that you should perform is the synthesis of solid copper(II) hydroxide from the copper(II) nitrate you made in the last step. This may be accomplished by adding 6 M sodium hydroxide to the copper solution.

5. Add 6 M sodium hydroxide to the beaker 1 mL at a time using a disposable transfer pipet. If you are unsure how to do this, you may find the instruction in the Common Laboratory Procedures section of the Appendix in this manual.
6. Add a minimum of sodium hydroxide, but also be sure that you have added enough to complete the reaction. The volume of sodium hydroxide added should be around 10-20 mL.
7. When the reaction is complete, add DI water to the beaker until the solution reaches 70 mL.

**Question B:** How do you determine that you have added enough sodium hydroxide?

**Question C:** Write the balanced chemical equation for the reaction in this step.

### C. Formation of the Oxide

8. To change the hydroxide to the oxide, slowly and carefully heat the solution containing the precipitate over a hot plate. Be sure to **stir the solution continuously** during the heating with a glass stir rod. Watch the solution carefully and record observations.
9. When the reaction is complete, remove the beaker from the hot plate and place the beaker on a piece of wire gauze while you continue to stir for a couple of minutes to avoid bumping of the cooling solution.

### Safety First

---

Continuously stir your solution to avoid bumping!

“Bumping” can occur when a large steam bubble forms within a solution due to a local region of overheating.

Bumping will cause a loss of product in addition to possible injury!

10. When the solution has cooled down, stop stirring and allow the product to settle. Once the product has settled, decant the liquid into a 400 mL beaker. Be careful not to lose any solid.
11. Next, wash the solid with hot deionized water. Let the solid settle again and decant the wash into your 400 mL waste beaker. Save the solid for the next step.

**Question D:** Write the balanced chemical equation for the reaction in this step. Assume the products are copper(II) oxide and water.

#### D. Formation of Copper(II) Sulfate

Copper(II) oxide will react with sulfuric acid to produce copper(II) sulfate. As with all reactions, use enough sulfuric acid to get the job done, but do not generate excess waste.

12. Perform this reaction using 3 M sulfuric acid. Add 3 M sulfuric acid to the copper oxide solids 1 mL at a time, until the reaction is complete. This volume should not exceed 10 mL.
13. Move back to the fume hood for the next step.

**Question E:** Write the balanced chemical equation for this reaction. Assume the products are copper(II) sulfate and water.

#### E. Formation of Copper Metal

14. Working in the fume hood, carefully and slowly add 0.5 g of zinc metal and stir. The reaction will be complete when the solution is colorless. Record your observations.
15. Add an additional 0.5 g of zinc if required. Do not add more than 1 gram of zinc in total. When the reaction is complete, decant the liquid into a clean beaker.
16. Examine the solid, if you note any solid zinc then add 10 mL of 6 M HCl and stir the solution until the zinc is no longer present.
17. When gas is no longer being produced, decant this solution. The liquid decantant should be poured into the cation metal waste container.

**Question F:** Write the balanced chemical equation for the reaction in this step. Assume the reactants are copper(II) sulfate and zinc, and that the products are copper metal and zinc sulfate.

**Question G:** Indicate the reducing agent and the oxidizing agent in this reaction.

**Question H:** Was the reaction between zinc and hydrochloric acid endothermic or exothermic? What was the gas produced in the reaction?

#### Quantitative transfer

---

*Quantitative transfer is the act of moving a solution from one container to another without losing any analyte.*

### F. Recovery of Copper Metal

You will dry and weigh your recovered copper solid in this step.

18. Begin by weighing your dry casserole dish.
19. Using your wash bottle, quantitatively transfer all the solid to the casserole dish. Stir the solid in the water to wash away water soluble impurities. Decant the water and wash two more times with 5 mL aliquots of deionized water.
20. Carefully and slowly heat the casserole on a hot plate. Watch this carefully and stir the solid with the glass end of the stir rod to prevent the solid from bumping.
21. Once the solid is completely dry, allow the casserole to cool, and weigh the casserole with the recovered copper.

#### Hint

The theoretical yield is the ideal yield you would have if there were no loss or contamination during the experiment.

The actual yield is the yield you actually obtained in the experiment.

**Question I:** Calculate the percent yield you obtained. This can be found by dividing the actual yield you obtained by the theoretical yield, and multiplying by 100.

**Question J:** Give reasons as to why you might expect your percent yield to be low. Give reasons as to why you might expect the percent yield to be high. Explain why your percent yield is high (>100%) or low (<100%).

#### Clean-Up:

- Clean all glassware that was used before leaving the laboratory.
- Clean the casserole by soaking it in 6 M nitric acid solution in the hood. **Do not use concentrated nitric acid for this step!**

## Data Analysis

---

### Making a solution of copper nitrate

1. In Part A of the experimental procedure, copper metal is added to concentrated nitric acid. The reaction between copper metal and concentrated nitric acid is an oxidation-reduction reaction that is somewhat complicated.



Consider the balanced chemical reaction given above. Assign the oxidation numbers to each atom in the equation. Note that oxidation numbers, other than zero, are written with the sign (+ or -) before the number.

2. Which element undergoes OXIDATION?
3. Which element undergoes REDUCTION?
4. How many moles of electrons are transferred between the elements being oxidized and reduced?

### Synthesis of solid copper(II) hydroxide

1. In Part B of the experimental procedure, you added 6 M sodium hydroxide to the copper(II) nitrate solution to form copper(II) hydroxide. You added a minimum amount of sodium hydroxide, but enough to complete the reaction. How do you determine that enough sodium hydroxide has been added?
2. Write a BALANCED chemical equation to represent the reaction of sodium hydroxide and copper(II) nitrate to form solid copper(II) hydroxide.

### Formation of the oxide

1. In Part C of the experimental procedure, the copper(II) hydroxide was heated and decomposed to copper(II) oxide and water. Write a BALANCED chemical equation to represent this reaction.

### Formation of copper(II) sulfate

1. In Part D of the experimental procedure, 3 M sulfuric acid is added to the copper(II) oxide to produce copper(II) sulfate and water. What is the BALANCED chemical equation for this reaction?

### Formation of copper metal

1. In Part E of the experimental procedure, 0.5 g of zinc is added to the copper(II) sulfate solution to produce copper metal and zinc sulfate. What is the BALANCED chemical equation for this reaction?
2. What are the oxidizing and reducing agents for this reaction?

## Reactions of Copper

3. In a 2nd reaction in step 5 of the experimental procedure, 6 M HCl is added to copper metal to remove any excess zinc metal. Is the reaction between the HCl and Zn exothermic or endothermic and what gas is released in this reaction? Hint: An exothermic reaction releases heat and an endothermic reaction absorbs heat.

### Recovery of copper metal

1. In Part A of the experimental procedure, you were instructed to retrieve 0.500-0.530 g of copper wire. What was the precise mass of your copper wire? Report your mass to a thousandth of a gram, i.e. 0.512 g.
2. In Part F of the experimental procedure, you dried your recovered copper. What was the precise mass of the recovered copper? Report your mass to a thousandth of a gram, e.g. 0.512 g.
3. Calculate the percent yield you obtained. Report your percentage to 3 significant digits, e.g. 89.3 %.
4. What factors would cause the percent yield to be LOW?
5. What factors would cause the percent yield to be HIGH?

# Colligative Properties

## Introduction

---

**Colligative properties** are the properties of a solution that depend on the amount of a chemical species in solution and not on the identity of the species in solution. Examples of these properties include boiling point elevation, freezing point depression, and osmotic pressure.

### Freezing Point Depression

In this experiment, you will study the second of these common examples using deionized water as a solvent. You may recall from your textbook that freezing point depression is described by the equation:

$$\Delta T_f = i \times K_f \times m$$

where  $\Delta T_f$  is the freezing point depression,  $i$  is a value known as the van't Hoff factor,  $K_f$  is the freezing point constant of the solvent, and  $m$  is the molality (not *molarity*) of the solution.

- **The freezing point depression ( $\Delta T$ )** is the difference between the freezing point of the pure solvent and the freezing point of the solution.
- **The van't Hoff factor ( $i$ )** is how many moles of particles are formed per mole of compound dissolved. For example, a solution of NaCl has a van't Hoff factor of  $i=2$ , a solution of  $MgCl_2$  has a van't Hoff factor of  $i=3$ , and a solution of a non-dissociating substance like sugar has a van't Hoff factor of  $i=1$ .
- **The freezing point constant ( $K_f$ )** is a constant that depends on the identity of the solvent.
- **Molality ( $m$ )** is the number of moles of solute per kilogram of solvent (mol/kg). For example, a solution made from 1 mol of sugar dissolved in 500 g of water will have a molality of 2 mol/kg. We use molality in this equation instead of molarity because molarity depends on the volume of the solvent, which in turn depends on the temperature of the solution.

## Cooling Curves

A **cooling curve** is a plot of temperature versus cooling time, constructed to analyze phase change. In this experiment, the cooling curve will be used to discover the freezing point of a solution.

In theory, a solution's temperature will fall until it reaches its freezing point, where it will experience a phase change before falling further. However, it is often possible for *supercooling* to occur, where the solution remains in the liquid phase while its temperature drops below its freezing point. Below is a cooling curve graph **without** the supercooling effect.

Cooling Curve without Supercooling Effect

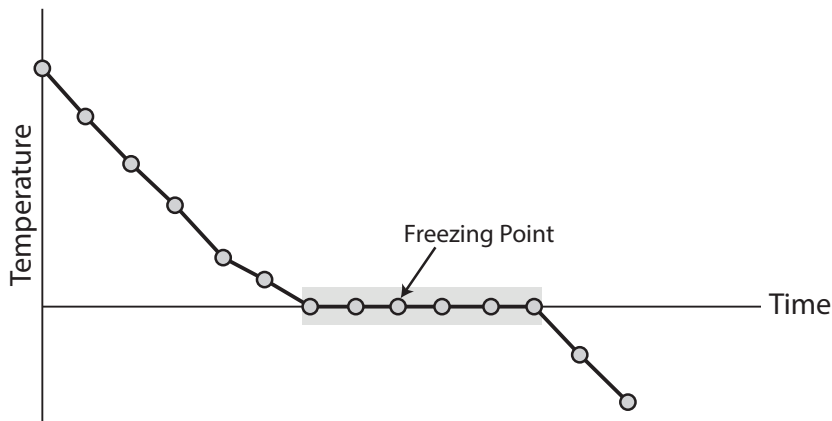

When the system is perturbed by the introduction of a small crystal, an outside perturbation of the system, or continued cooling, the supercooled liquid may suddenly convert to a solid while its temperature rises to its freezing point. Below is a cooling curve graph showing the supercooling effect.

Cooling Curve with Supercooling Effect

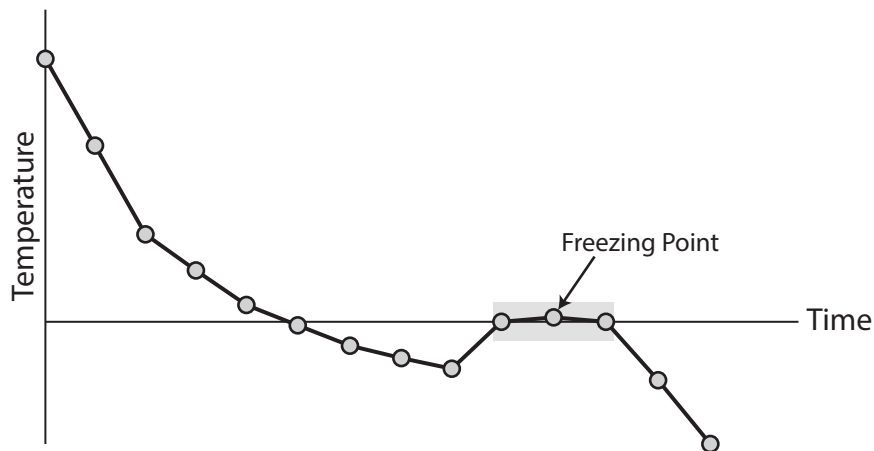



**Experiment Overview**

During this experiment, you will first measure the normal freezing point of water in your experimental apparatus. This will require the use of a cooling bath prepared from salt, ice, and water. In the second part of the experiment you will measure the freezing point of a solution of water with sodium chloride as a solute, in order to determine the freezing point depression constant ( $K_f$ ) for water. Finally, you will use the  $K_f$  that you have determined in Part II to find the molar mass of an unknown solute. .

**Cryobiosis: now that's super cool!**

Ever wonder how some fish and frogs can survive the winter in a frozen pond? The answer lies within cryobiosis, the ability of an organism to survive being frozen, oftentimes through the use of cryoprotectants. Cryoprotectants are chemicals, such as glucose or glycerol, that depress the freezing point of water within an organism and prevent formation of harmful ice shards.

A master of cryobiosis is the magnificent Tardigrade, an animal commonly known as "water bears" or "moss piglets". Tardigrades are able to withstand freezing, heating, extreme pressure, dehydration, radiation, starvation, oxygen deprivation, and the vacuum of space. Tardigrade's exact method of cryobiosis is still a mystery to scientists, but may involve the use of cryoprotectant proteins.

## Learning Goals

---

The following is a list of skills that you will use in this experiment.

<b>Laboratory</b>	<ul style="list-style-type: none"><li>• Preparing a cooling bath</li><li>• Using a freezing point apparatus</li></ul>
<b>Conceptual</b>	<ul style="list-style-type: none"><li>• Colligative properties</li><li>• Freezing point depression</li><li>• Molality</li><li>• van't Hoff</li></ul>
<b>Data Analysis</b>	<ul style="list-style-type: none"><li>• Analyzing a cooling curve</li><li>• Calculating <math>K_f</math> using <math>\Delta T_f = i \times K_f \times m</math></li><li>• Calculating molar mass of an unknown using molality</li></ul>

## Procedure

---

**Work in pairs** on this experiment.

Each student must collect data and submit a separate report. The actual data analyses and the written reports must be done entirely independently of your lab partner or other students. Make sure that you avoid unauthorized collaboration and plagiarism. All suspected violations of the Code of Academic Conduct will be referred to Student Judicial Affairs.

### Stock Chemicals Used

Chemical	Maximum Amount Used
Sodium chloride	0.4–0.6 g
Unknowns A, B, C	Follow Label Instructions A: 1 g B: 2 g C: 3 g

### Safety First

Wear your goggles and gloves throughout this experiment.

### Part I. Determining the Freezing Point of Water

1. Check out a LabQuest, a Go!Temp temperature probe, and a freezing point apparatus from your TA.
2. Prepare the **cooling bath** with an 800 mL beaker.
  - a. Using a 400 mL beaker, transfer 300 mL of ice to the 800 mL beaker.
  - b. Acquire approximately 100 mL of rock salt into a 150 mL beaker. Add half of the rock salt into the 800 mL beaker.
  - c. Add to the cooling bath another 300 mL of ice and the rest of the rock salt.
  - d. Add 100 mL of DI water to the chilled 400 mL beaker. Rinse the wall of the beaker and pour the cooled water into the ice bath.
  - e. Using a glass stir rod, gently stir the mixture to ensure thorough mixing.
  - f. Place the 800 mL beaker in the Styrofoam box provided.

### Green Chemistry

It is extremely important that you conserve ice in this experiment.

Never use more ice than instructed. Always reuse ice when possible.

3. Prepare the **freezing point apparatus**.
  - a. Using a 10 mL volumetric pipet, accurately transfer 10.00 mL of DI water into the freezing point apparatus.
  - b. Set up the apparatus as shown below. Assemble the test tube of the apparatus with the cap, thermometer, and stirrer.

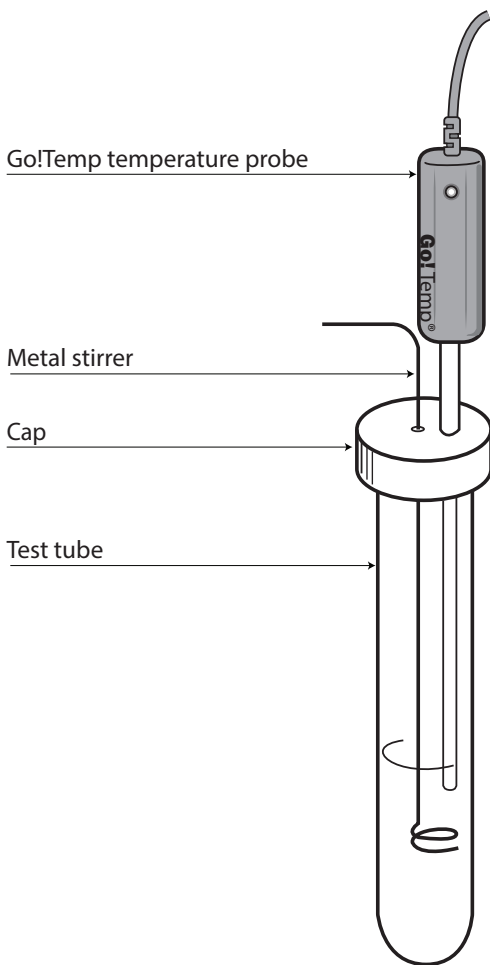

Figure 1. Freezing point apparatus with Go!Temp temperature probe.

4. Set up the LabQuest.
  - a. Connect the Go!Temp temperature probe to the LabQuest.
  - b. Turn on the LabQuest.
  - c. Browse to the **Sensors** (📡) tab, tap **Sensors** at the top, and select **Data Collection...** from the drop-down menu.

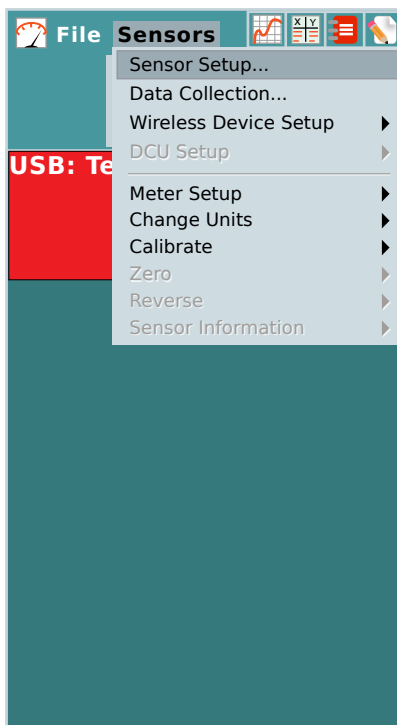

Figure 2. The main screen of the LabQuest connected to the Go!Temp.

- d. Start by setting the interval to 1 s/sample and the duration to 800 s. This makes the LabQuest record 1 temperature reading from the Go!Temp every second for 800 seconds, for a total of 800 readings. Leave all other settings unchanged. Press OK.

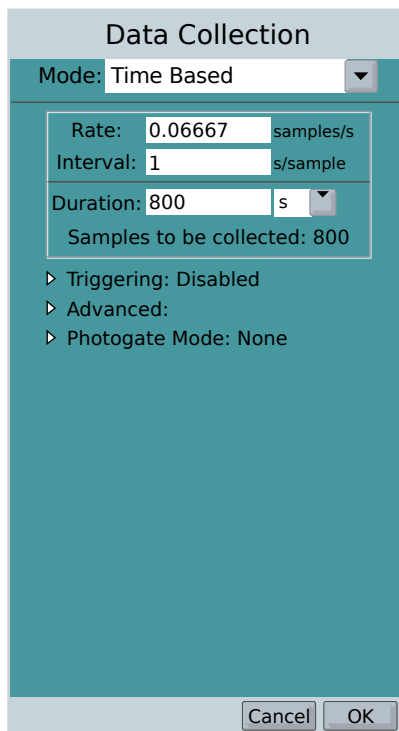

Figure 3. The Data Collection settings page.

- e. Click on the Graph tab (📊).

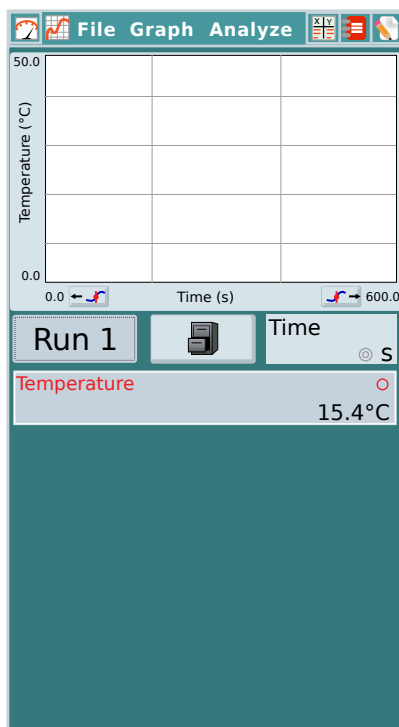

Figure 4. The Graph tab displaying a blank graph.

5. Measure the freezing point of **water**.
  - a. Keep a glass thermometer in the cooling bath. Ensure the bath is at a temperature of  $-10\text{ }^{\circ}\text{C}$  or less.
  - b. Place the freezing point apparatus in the ice-water bath so that the Go!Temp and the DI water inside the freezing point apparatus are submerged under the ice.
  - c. Start the data collection by pressing the Start (▶) button. Collect the necessary data to construct a cooling curve by measuring and recording the temperature and time as the solution cools.
 

The correct freezing point is when the temperature stops decreasing, or plateaus. Be mindful of potential supercooling effects.

Be sure to consistently stir the sample during data collection.
  - d. Press the Stop (■) button to stop data collection once you have reached a temperature plateau.
 

Choose 3 or 4 points from the flattest portion of the graph and take the average of these to use as your freezing point.

### Hint

One student can stir and read the thermometer while the other records the temperature.

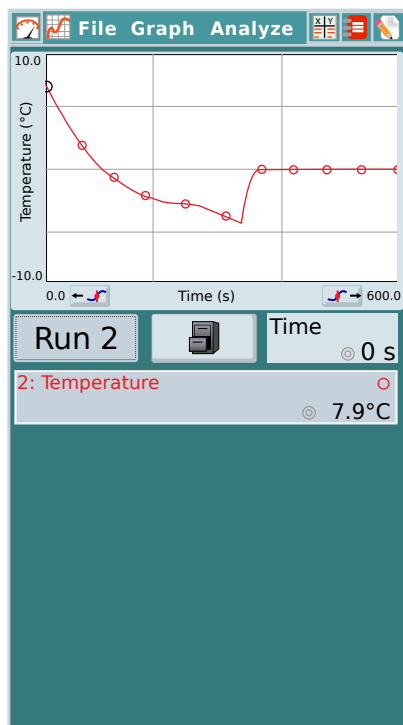

Figure 5. A temperature curve showing the supercooling effect.

### For this lab

---

- Be sure to consistently stir the sample mixture by raising and lowering the metal stirrer carefully thoroughly thereby maintaining a uniform temperature as the solution cools.
  - Insufficient stirring will cause non-uniform cooling, and stirring too vigorously will cause the solution to splash and freeze on the side of the test tube.
- 
6. Perform at least 3 trials to obtain good precision in your measurements. (The melting points should be within 0.5 °C of each other.)  
Freeze and melt the same sample for all trials.
  7. **Clean up:** Melt the sample by placing the test tube in a beaker of room temperature water with stirring until melting is complete. Do not allow the solvent to return to room temperature.
  8. **Save** the solvent and cooling bath for Part II.



## Part II. Determining the Freezing Point Constant for Water

In this part of the experiment, you will collect data that will allow you to determine the  $K_f$  for water. You can do this by adding a known quantity of solute to the DI water solvent and measuring the freezing point of the mixture.

1. Prepare the **freezing point apparatus**.
  - a. Allow the solution in the freezing point apparatus to warm to room temperature.
  - b. Weigh out 0.4–0.6 g of sodium chloride, NaCl. Record the mass to the nearest thousandth of a gram (0.001 g). Carefully add the solid to the solvent at room temperature. Stir the mixture until the sodium chloride is completely dissolved.
  - c. Reassemble the freezing point apparatus and stir the solution with the metal stirring rod to ensure complete mixing.

2. Prepare the **cooling bath**.
  - a. Measure the temperature of the cooling bath to ensure it is  $-10\text{ }^\circ\text{C}$  or lower.
  - b. If the ice bath is not cool enough, pour off the water but save the ice and salt mixture.

Repeat the instructions in Part I to prepare the cooling bath, starting with adding more ice to the left-over ice/salt mixture.

3. Measure the freezing point of the **NaCl solution**.
  - a. Keep a glass thermometer in the cooling bath. Ensure the bath is at  $-10\text{ }^\circ\text{C}$  or less.
  - b. Place the freezing point apparatus in the ice-water bath so that the solution is well submerged. Ensure the thermometer is also submerged in the solvent.
  - c. Collect the necessary data to construct a cooling curve by using the LabQuest and Go!Temp to measure and record the temperature and time as the solution cools.

Remember to stir the solution. Be mindful of potential supercooling effect when determining the freezing point. Do not be impatient.

- d. When you thaw the solution, only allow it to warm about  $5\text{ }^\circ\text{C}$  **above** its freezing point.

If you let the solution return to room temperature between each trial, this experiment will take an inordinate amount of time.

### Hint

---

One student can stir and read the thermometer while the other records the temperature.

4. **Clean-up:** After the data has been collected, pour the solution from the freezing point apparatus into the sink. Rinse out the test tube, metal stirrer, and your thermometer.
5. **Save** the cooling bath for Part III.

### Part III. Determining the Molar Mass of Solute

In this part of the experiment, you will design an experiment to determine the molar mass of an unknown substance.

Your experimental design will be similar to the procedures used in part II. Some unidentified solutes are provided in the laboratory.

There are recommended mass ranges on the bottles, since different solutes will require different masses. Furthermore, the solute may be slow to dissolve. However, complete dissolution is essential for molar mass determination.

1. Prepare the **cooling bath**.
  - a. Measure the temperature of the cooling bath to ensure it is  $-10\text{ }^{\circ}\text{C}$  or lower.
  - b. If the ice bath is not cool enough, pour off the water but save the ice and salt mixture. Repeat the instructions in Part I to prepare the cooling bath, starting with adding more ice to the left-over ice/salt mixture.
2. Acquire the unknown. Record the letter of the unknown in your notebook.
3. Determine the molar mass of the unknown.

#### Clean-Up:

- After the data has been collected, pour the solution into the sink.
- Clean the freezing point apparatus by rinsing out the test tube, stirrer, and the Go!Temp temperature probe.
- Use the strainer provided in lab to collect the left-over rock salt in the designated container.
- Return the LabQuest and Go!Temp probe to your TA.

## Data Analysis

---

### Determining the Freezing Point of Water

1. The expression for the freezing point depression of a solution relative to that of the pure solute is given by  $\Delta T_f = i \times K_f \times m$ . From solutions of known concentrations of sodium chloride in water, you can determine  $K_f$ , the freezing point depression constant of water. What assumption is necessary in order to do this calculation?
2. For each of your 3 trials, what was the freezing point of pure water? Report values to the nearest 0.1 °C.
3. Calculate the average freezing point of the pure water.

### Determining the Freezing Point Constant ( $K_f$ ) for Water

1. For each of your trials, what is the volume of water in your NaCl solution?
2. For each of your trials, what is the mass of water in your NaCl solution? Assume the density of water at 21 °C is 0.9980 g/mL.
3. For each of your trials, what is the mass of sodium chloride (NaCl) in your NaCl solution?
4. Use the values determined in steps 1-3 to calculate the molality of your NaCl solution for each trial. Remember that molality is defined as moles of solute per kilogram of solvent.
5. For each of your trials, what was the freezing point of your NaCl solution?
6. For each of your trials, use the average freezing point of pure water to calculate the freezing point depression of your NaCl solution,  $\Delta T_f$ . Freezing point depression is calculated by taking the absolute value of the freezing point of your NaCl solution subtracted from the average freezing point of pure water.
7. What is the van't Hoff factor of sodium chloride dissolved in water?
8. For each of your trials, calculate the  $K_f$  of water using the equation  $\Delta T_f = i \times K_f \times m$ .
9. Calculate the average of your  $K_f$  values.
10. Calculate the standard deviation of your  $K_f$  values.
11. Calculate the 90% confidence limit of the average  $K_f$  value.
12. Why is salt (NaCl) added to the ice-water mix in Part II?

### Determining the Molar Mass of a Solute

1. What is the van't Hoff factor for your unknown compound (a nonelectrolyte)?
2. For each of your trials, what is the mass of unknown solute added to water (in grams)?
3. For each of your trials, what is the volume of water in your solution?

## Colligative Properties

4. For each of your trials, what is the mass of water in your solution? Assume the density of water at 21 °C is 0.9980 g/mL.
5. For each of your trials, what was the freezing point of your solution?
6. For each of your trials, use the average freezing point of pure water to calculate the freezing point depression of your solution,  $\Delta T_f$ . Freezing point depression is calculated by taking the absolute value of the freezing point of your solution subtracted from the average freezing point of pure water.
7. Using the equation  $\Delta T_f = i \times K_f \times m$ , calculate the molar mass of the unknown solute for each trial.

Hint: Start by using the above equation to calculate the molality of solution (moles of solute per kilogram of solvent). In step 4 you determined the mass of water in solution. How can this be used, along with molality, to determine the moles of solute present in solution? What value can you then use to calculate the molar mass of the unknown solute?

8. Calculate the average molar mass of the unknown solute.
9. Calculate the standard deviation of the molar mass values of the unknown solute.
10. Calculate the 90% confidence limit of the average molar mass of unknown solute.
11. Based on the data you collected and calculations you performed, please determine which of the following compounds you think to be your assigned unknown based on your calculated molar mass:
  - Catechin (MW: 290.26 g/mol)
  - Urea (MW: 60.06 g/mol)
  - Cadaverine (MW: 102.18 g/mol)
  - Sucrose (MW: 342.30 g/mol)
  - Formaldehyde (MW: 30.03 g/mol)
  - Glucose (MW: 180.16 g/mol)

# A Brief Introduction to Spectrophotometry

## Introduction

---

Many substances absorb photons in the visible light region of electromagnetic radiation spectrum while reflecting other photons in the visible light region. As a result of the reflected photons, a particular substance appears a certain color. The color you attribute to the material is actually all the remaining reflected light. In general, the apparent color of a solution is always the complement of the color being absorbed. For example, a solution may appear red if it absorbs green light.

**Spectrophotometry** is a method of determining the concentration of a substance in solution by measuring how much a chemical substance absorbs light when a beam of light passes through the solution. The word spectrophotometry is composed of the word roots “*spectro*,” which refers to the electromagnetic spectrum, “*photo*,” which means light, and “*meter*,” which means to measure. In general, spectrophotometry involves the use of a spectrophotometer to measure a solution’s absorbance of electromagnetic radiation near the visible light region of the spectrum. When the radiation used are limited to the visible spectrum, this type of analysis may also be called **colorimetry**.

If we measure the amount of light that is going into the sample and we measure the amount of light that comes out, we can determine to what extent the sample is absorbing the light. The absorption characteristics for substances of different colors are always different. A spectrophotometer may be used to analyze these differences by measuring how much light is absorbed at different wavelengths. The Greek letter lambda ( $\lambda$ ) is used to denote wavelength. The visible region of the electromagnetic spectrum includes waves with  $390\text{nm} \leq \lambda \leq 700\text{nm}$ .

## A Brief Introduction to Spectrophotometry

The absorbance characteristics of a substance may be analyzed by measuring how much a substance absorbs light at discrete wavelengths ( $\lambda$ ), and plotting the result. This is called an **absorbance spectrum**. Below is the absorbance spectrum of phenolphthalein, the indicator you used in the previous experiment, in a solution at pH 10.

Absorbance Spectrum of Phenolphthalein

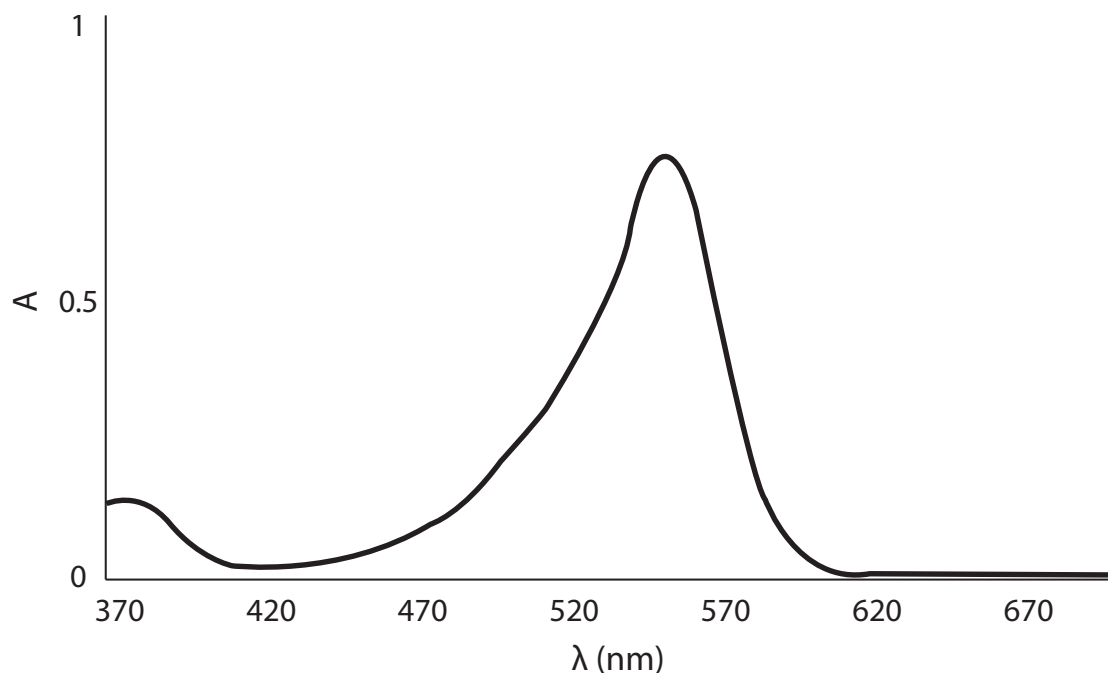

The plot shows that the indicator absorbs strongly in the 500–600 nm range (green and yellow), and absorbs moderately in the 370–400 nm range (violet), but does not absorb light in the 600–700 nm region (orange and red). As a result, light that passes through this indicator often appears pink or purple.

## The Spectrophotometer

---

A spectrophotometer is an instrument which measures the fraction of light ( $I/I_0$ ) that is absorbed by a sample. The sample is placed in a tube called a **cuvette** and is then irradiated with an incident beam of light ( $I_0$ ) of a specific wavelength ( $\lambda$ ). A detector then measures the amount of light that is transmitted through the sample ( $I$ ). A schematic representation of a spectrophotometer is shown below.

### A schematic representation of a spectrophotometer

---

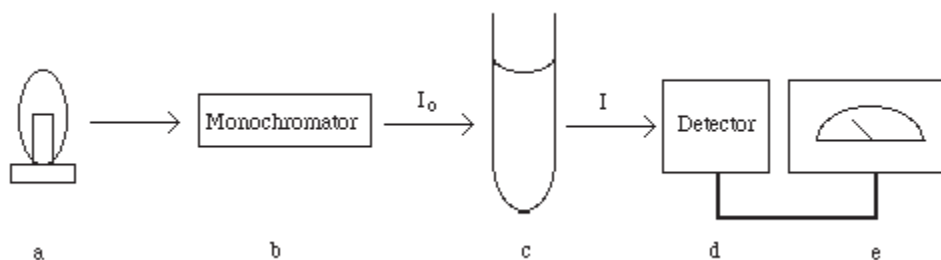

- a. **Light source:** produces a polychromatic beam of light.
  - b. **Monochromator:** selects a particular wavelength for incident light ( $I_0$ ).
  - c. **Sample cell.**
  - d. **Detector:** measures the intensity of the transmitted light ( $I$ ).
  - e. **Display:** displays the absorbance or transmittance reading.
- 

For any substance, the amount of light absorbed depends on: 1) the concentration of the absorbing species, 2) the length of solution that the light passes through (commonly called the path length), 3) the wavelength of incident light, and 4) the identity of the absorbing species present.

The amount of light absorbed by a solution is measured indirectly as the fraction of the amount of light that passes through the sample ( $I/I_0$ ), where ( $I_0$ ) is the amount of light before it passes through the sample, and  $I$  is the amount of light measured after it passes through the sample. This measurement is called **transmittance**, denoted by  $T$ , where

$$T = \frac{I}{I_0}$$

Notice that  $T = 0$  if the solution completely absorbs all light, and  $T = 1$  if the solution absorbs no light at all. While transmittance is easy to measure, it is not very useful in spectrophotometry, where we are interested in using the relationship between how much substance there is in a solution and how much light the solution absorbs.

## A Brief Introduction to Spectrophotometry

Another common method to express the amount of light absorbed is absorbance, denoted by  $A$ , where

$$A = -\log_{10} T$$

Absorbance is a useful measurement because it relates directly how much a light-absorbing substance is in solution to how much the solution absorbs light. Consider the following examples:

- a. a solution that is completely transparent ( $T = 1$ ), has  $A = 0$ ;
- b. a solution that absorbs half the light through it ( $T = 0.5$ ), has  $A = 0.301$ ;
- c. a solution that absorbs 90% of the light through it ( $T = 0.1$ ), has  $A = 1$ .

As the amount of light-absorbing substances increase, so does the absorbance.

Keep in mind that transmittance and absorbance are functions of the ratio of light intensity before and after it passing through the sample. Therefore, they are both dimensionless, i.e. they have no units of measurement.



## Beer's Law and The Standard Curve

---

### Beer's Law

Absorbance may be directly related to the molar concentration using a simplified form of the Beer-Lambert Law, also known as **Beer's Law**:

$$A = \epsilon \ell C$$

where  $A$  is the **absorbance**,  $C$  is the **molar concentration**,  $\ell$  is the **path length** of light through the solution, and  $\epsilon$  is the **molar absorptivity**.

- **Absorbance** ( $A$ ) is a unitless value describing how much light is prevented from passing through a substance. Absorbance depends on the wavelength of light; some wavelengths are more easily absorbed by a substance than others. An absorbance of 0 means that no light was absorbed by a substance, and it is completely transparent. An absorbance of 100 means that all light was absorbed. The opposite of absorbance is transmission, or how much light is able to pass through a substance.
- **Molar absorptivity** ( $\epsilon$ ), also known as the extinction coefficient, is a constant that shows how well a specific substance absorbs light of a particular wavelength. In this experiment we will use a version of molar absorptivity called **effective molar absorptivity** ( $\epsilon^*$ ), which takes into account the pathlength ( $\ell$ ) of the sample. In the data analysis of this experiment, effective molar absorptivity is equal to molar absorptivity multiplied by path length ( $\epsilon^* = \epsilon \ell$ ).
- **Path length** ( $\ell$ ) is the distance that light travels through a sample.
- **Concentration** ( $C$ ) is the concentration of substance in a solution, usually in molarity.

A plot of a solution's concentration vs. absorbance clearly shows this linear relationship, commonly expressed as  $y = mx + b$ , where  $y = A$ ,  $x = C$ ,  $m = \epsilon \ell$  (the slope) and  $b = 0$  (the y-intercept). Because we will be using cuvettes of the same specification for this experiment, the path length ( $\ell$ ) is the same for all measurements. As such we will combine  $\epsilon \ell$  into one constant,  $\epsilon^*$  to denote the slope. Notice that  $\epsilon^*$  has a unit of  $M^{-1}$ , because  $A$  is a dimensionless quantity. This plot is called the Beer's Law plot.

$$A = \epsilon^* C$$

While Beer's Law is very useful for interpolating concentrations, be aware that Beer's Law does not necessarily hold for all substances or at all concentrations. For example, it often fails at high concentrations.

## Standard Curve

An experimentally-derived graph of the concentration vs absorbance of analytical standards also known as a standard curve or calibration curve. A standard curve is often a useful way to perform quantitative analysis. It is possible to estimate the concentration of a solution by interpolating the data from a standard curve using Beer's Law.

It is important to remember that a standard curve may not always be linear. When performing calculations with Beer's Law, do not extrapolate outside the linear region of the standard curve. As shown on the graph below, the absorbance values fail to follow Beer's Law's at high concentration.

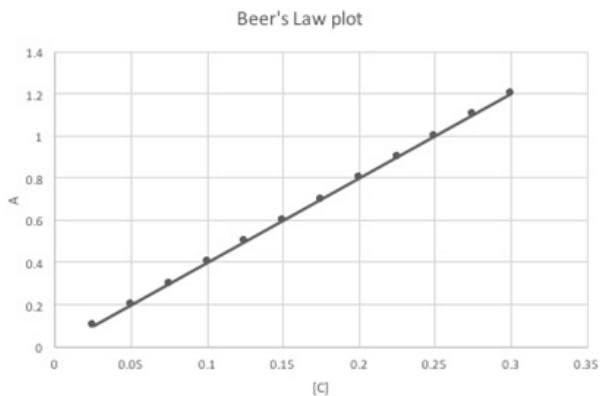
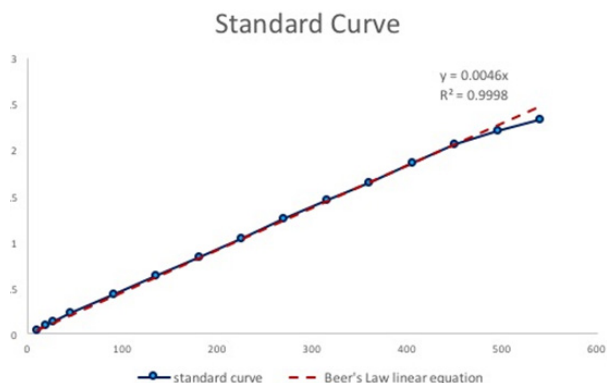

## Operations of The VSPEC Spectrometer With LabQuest 2

### Overview

Spectrophotometers all contain some kind of light source (visible instruments often use just a tungsten bulb); various mechanical and optical elements which are used to create a directed and collimated beam; a wavelength selector of some sort (often either a diffraction grating or a prism); an enclosed cell compartment to hold the absorbing sample; a radiation detector (which may be a photodiode, a photodiode); and some kind of readout device (e.g. a needle deflection on a meter). Below is a simplified diagram the optical path of a typical spectrophotometer.

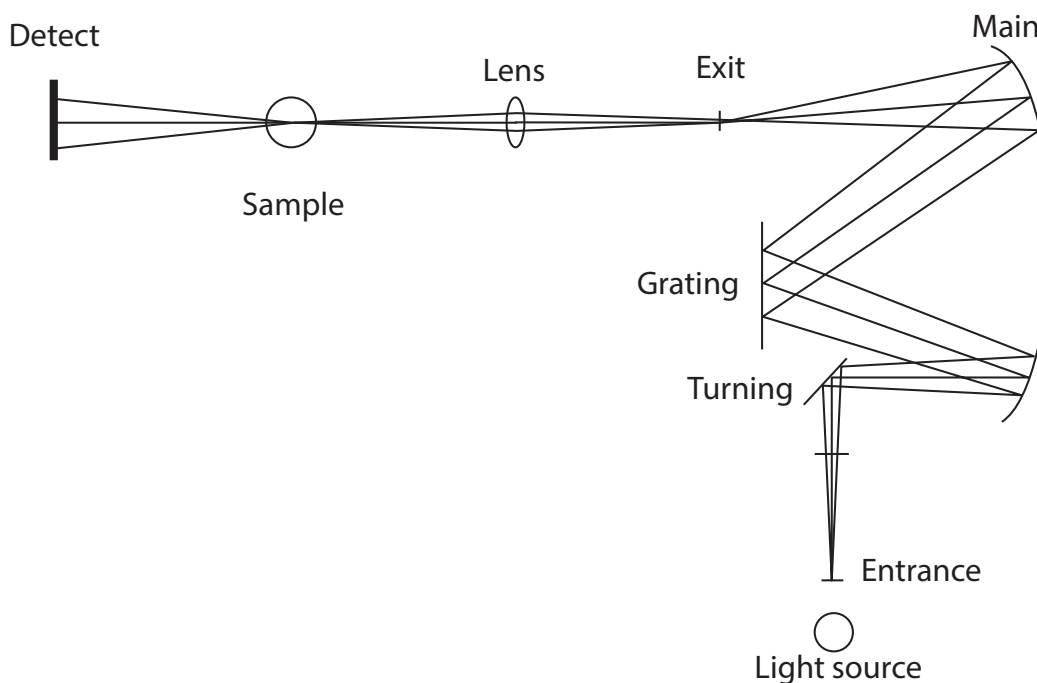

**Figure 1. The optical path of a typical spectrophotometer.**

In this experiment, you will be using a Vernier VSPEC spectrometer that can measure light over a wide range of wavelengths simultaneously. The light path in this instrument is shown in a simplified diagram on the next page. Note that instead of using optics to select a narrow range of wavelengths, all wavelengths are measured at the same time by the detector, a linear CCD array. (CCD stands for charge-coupled device, which is the same kind of electronics device used in digital cameras and scanners.)

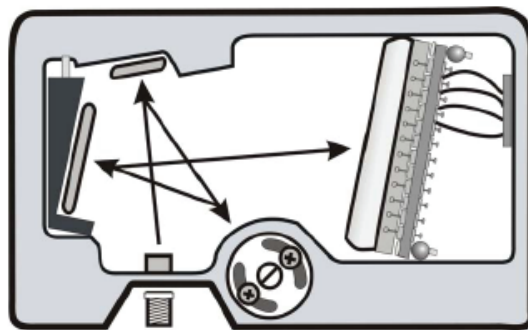

**Figure 2.** The light path inside the VSPEC spectrometer.

The light source is a violet LED-boosted tungsten bulb (390–900 nm) integrated into a package including the cell holder that attaches directly to the spectrometer. The light from the lamp passes through the cell and then enters the spectrometer through an entrance slit. The light is then reflected from a collimating mirror and is dispersed by a diffracting grating. The resulting dispersed light is reflected from a focusing mirror and then strikes the solid-state CCD detector that generates an electrical signal proportional to the radiant power (light intensity) at each wavelength. The signals from the detector are transmitted to a computer where software plots the spectrum, on the display in transmittance or absorbance units.

The cuvettes used have a path length (internal diameter) of 1.00 cm. The light transmitted through the sample strikes a solid-state silicon detector that generates an electrical signal proportional to the radiant power (light intensity). The signal from the detector drives a meter that can be calibrated to read transmittance or absorbance.

The calibration procedure entails setting the absorbance value at 0 at a given wavelength with a cuvette containing a reference or blank solution. The blank solution is missing the component of interest, but is otherwise as identical as possible to the solution to be analyzed for the component of interest. Typically, the blank solution is just the solvent. This is required since the output of the lamp and the sensitivity of the detector varies with wavelength. Once calibrated, the spectrophotometer will account for any absorption, reflection, or scattering of the light by the cuvette and other species in the reference solution.

### Handling of Cuvettes

The proper handling of a cuvette is important. Often one cuvette is used for reference, and a second cuvette for the sample. Any variation in the two cuvette (smudges or scratches on the surface, etc.) will cause errors. There are several important precautions to follow:

1. Do not handle the lower portion of the cuvette, through which the light passes.
2. Wipe off any liquid drops or smudges on the lower portion of the cuvette with a clean, supplied Kimwipe. Do not use paper (which may scratch the cuvette) or cloth towels (which may leave lint).
3. Insert the cuvette into the spectrometer carefully to avoid any possible scratching of the plastic surface.

### Spectrometer Set-up

The V-SPEC spectrometer and LabQuest 2 data collection device should already be set up at your station as diagrammed.

If not, connect the V-SPEC spectrometer to the LabQuest with the USB cable connected. Plug the LabQuest power supply to an electrical outlet. Do not move the instruments away from your station!

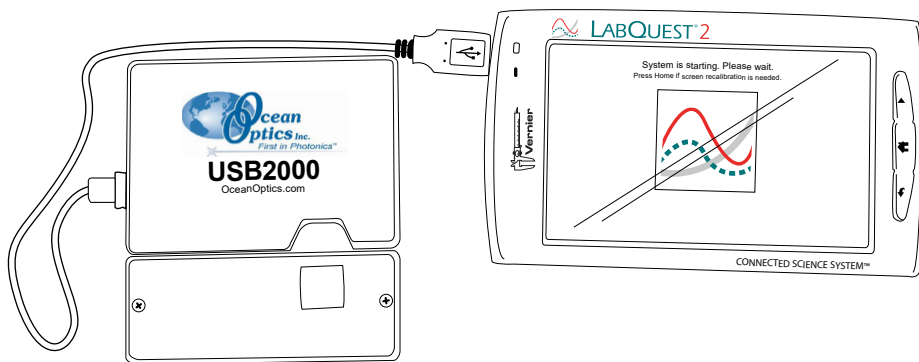

Figure 3. A diagram of the LabQuest 2 and spectrometer setup.

1. Press the home button (🏠) on the LabQuest to go to the LabQuest main menu.
2. Open the LabQuest app.
3. Choose **New** from the **File** menu.

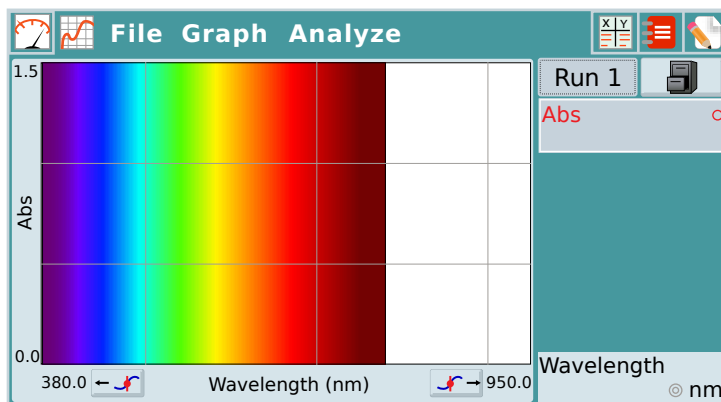



Figure 4. The LabQuest app showing a spectrometer connected.

### Calibration

1. Perform calibration only after all data collection configurations are set. Calibration should be the last step you do before you begin collecting sample data.
2. Go to the **Sensors** tab by clicking on the  button.
3. From the **Sensors** menu, choose to **Calibrate**.

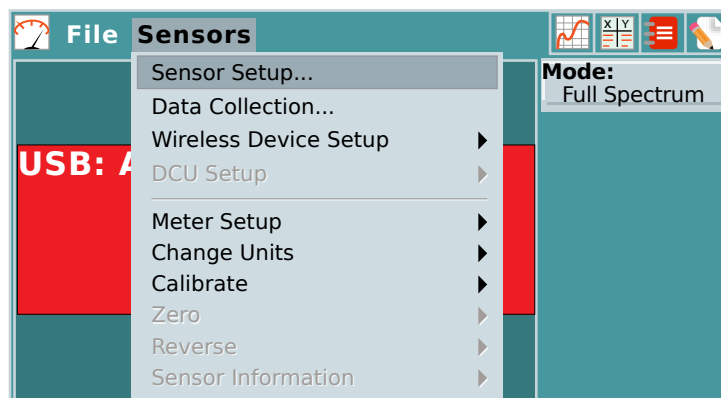

Figure 5. The Sensors drop-down menu.

4. The calibration dialog box will display the message: “Waiting 90 seconds for lamp to warm up.”
5. While the lamp is warming up, fill a cuvette  $\frac{2}{3}$  full with your blank solution. This amount insures that all incident radiation passes through the solution.

Wipe the outside of the cuvette with a Kimwipe. Insert the blank cuvette into the cuvette holder in the correct orientation. The triangle on the cuvette should line up with the direction of the light.

6. Wait until the message changes to “Warm-up complete.” Choose **Finish Calibration**, and wait for the calibration to complete. Choose **Ok** to complete the calibration process. Note that you only need to allow the lamp to warm up **once, at the start of the experiment**. You can choose **Skip Warmup** on all subsequent calibrations during the lab period.

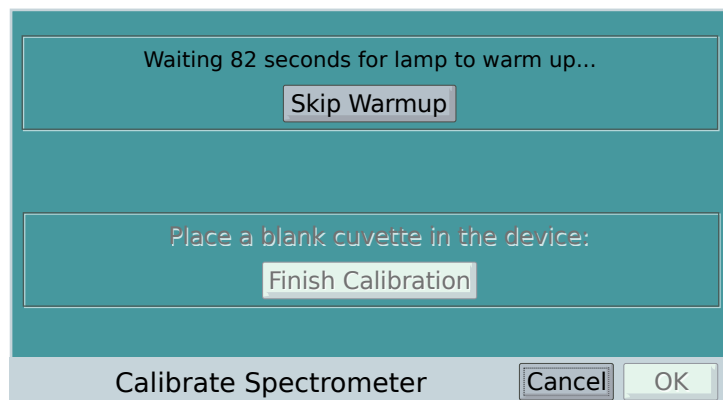



Figure 6. The warm-up message shown during initial calibration.

### Measuring the Full Spectrum Absorbance of a Sample (Absorbance vs. Wavelength)

1. Click on the **Sensor** tab .
2. From the **Sensor** menu, choose **Data Collection...**
  - a. Change the mode of data collection to **Full Spectrum**.
  - b. Ensure the **Wavelength Range** shown is 380 nm – 950 nm.

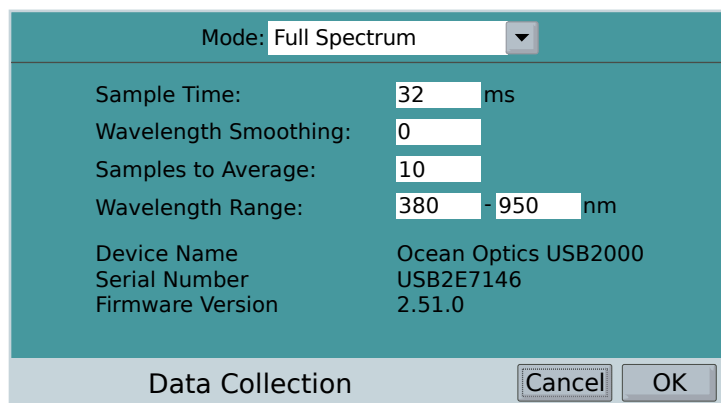

Figure 7. The Data Collection screen.

3. Calibrate with the blank cuvette.
4. Place the cuvette with sample of interest in the cuvette holder.
5. Start the data collection by clicking on the ► button. Absorbance data for the full spectrum from 380 nm to 950 nm will be collected, displayed, and updated continuously.
6. Stop the data collection by clicking on the ■ button.

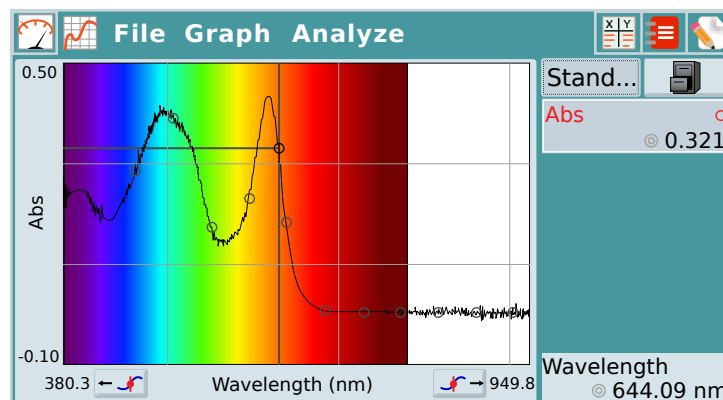



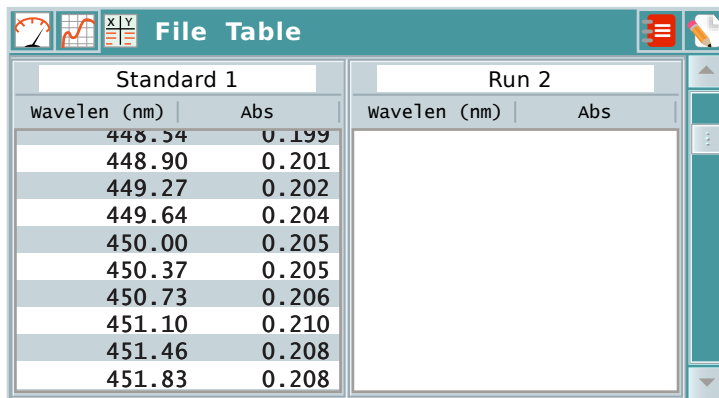

Figure 8. A sample absorbance spectrum.

7. Examine the absorbance at different wavelengths by moving the cursor over the spectra. Alternatively, examine the **Data Table** tab by clicking on the  button.
8. Record the wavelength and corresponding absorbance values of interest in your lab notebook.

## A Brief Introduction to Spectrophotometry

9. Store the spectra by clicking on the  button.
10. Go to the **Data Tables** tab by clicking on the  button. Rename the data in the Data Tables tab by clicking on the column header and enter the identity and/or concentration of the sample.



Standard 1		Run 2	
waveLen (nm)	Abs	waveLen (nm)	Abs
448.54	0.199		
448.90	0.201		
449.27	0.202		
449.64	0.204		
450.00	0.205		
450.37	0.205		
450.73	0.206		
451.10	0.210		
451.46	0.208		
451.83	0.208		

Figure 9. The Data Tables tab showing default data column names.

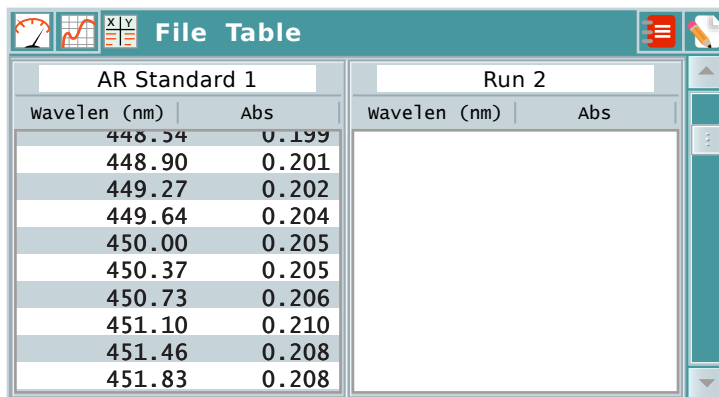

AR Standard 1		Run 2	
waveLen (nm)	Abs	waveLen (nm)	Abs
448.54	0.199		
448.90	0.201		
449.27	0.202		
449.64	0.204		
450.00	0.205		
450.37	0.205		
450.73	0.206		
451.10	0.210		
451.46	0.208		
451.83	0.208		

Figure 10. The Data Tables tab with the identity of the sample entered in the header.

11. Move on to the next sample.



# Spectrophotometry

## Introduction

---

<b>Nutrition Facts</b>	<b>Amount/Serving</b>	<b>% DV*</b>
Serv Size 1/8 package (0.6g) (makes 8 fl oz)	<b>Total Fat</b> 0g	<b>0%</b>
Servings 8	<b>Sodium</b> 10mg	<b>0%</b>
<b>Calories 0</b>	<b>Total Carb.</b> 0g	<b>0%</b>
*Percent Daily Values (DV) are based on a 2,000 calorie diet.	<b>Protein</b> 0g	
	<b>Vitamin C</b>	<b>10%</b>

Not a significant source of Fat Cal, Sat Fat, Trans Fat, Cholest, Fiber, Sugars, Vitamin A, Calcium, and Iron.

**INGREDIENTS:** CITRIC ACID, MALTODEXTRIN, SALT, NATURAL FLAVOR, CALCIUM PHOSPHATE, CONTAINS LESS THAN 2% OF ASCORBIC ACID (VITAMIN C), ARTIFICIAL FLAVOR, ARTIFICIAL COLOR, RED 40, YELLOW 5, BHA (PRESERVATIVE).

**Figure 1. Nutrition Facts and Ingredients for Kool-Aid.** Notice the artificial colorants Red 40 and Yellow 5.

Have you ever eaten a bowl of multicolored cereal and sworn that each color tastes different? When you open a pack of fruity candy, which color do you reach for first? Color tells us a lot about the foods we eat, especially in a day and age where most people no longer grow their own food, and much of what we eat is packaged or manufactured.

Food colorants are used to make products more appealing to consumers by either imparting a new color or enhancing the natural color of the food. Within the United States, food colorants are regulated by the Food and Drug Administration (FDA). Food colorants can be placed into one of two categories: artificial and natural. Artificial colorants are synthetically manufactured, while natural colorants are obtained from plants, animals, or minerals. The two food dyes we'll be using in this lab, Tartrazine and Allura Red AC, are artificial food colorants. Some examples of natural food colorants include beta-carotene, an orange chemical isolated from carrots, and carmine, a bright red dye made from cochineal scale insects.

In this experiment, you will spectrophotometrically analyze the concentration of food coloring in solution. To do this, you will use a **spectrophotometer**, an instrument which measures the amount of light absorbed by a sample. Make sure you read and understand the basic principles of spectrophotometry discussed in *A Brief Introduction to Spectrophotometry*. The spectrophotometer is an expensive and sensitive instrument and must be operated carefully and intelligently.

### **Recap: Beer's Law**

We can see through our own visible observations that light passing through an empty glass looks different than light passing through a glass full of water, or a glass full of Kool-Aid. The way light travels through a substance can be described using Beer's Law, also known as the Beer-Lambert Law. Beer's Law states that the amount of light absorbed or transmitted by a substance is proportional

to the substance's concentration and its molar absorptivity. This relationship is described using the following equation:

$$A = \epsilon \ell C$$

where  $A$  is absorption,  $\epsilon$  is molar absorptivity,  $\ell$  is path length, and  $C$  is concentration of the solution. Refer to *A Brief Introduction to Spectrophotometry* for an extended explanation of Beer's Law.

### Solution Concentration & Dilution

To prepare a **Beer's Law plot**, a plot of concentration vs. absorbance, it is essential that you are able to accurately prepare solutions of different concentrations, and to calculate the concentrations of the solutions you have prepared. Understanding solution concentrations and **dilution** is essential for this experiment.

### Describing Solution Concentration

You should now be adept at working with **molarity** and **mass percent** when calculating solution concentration. As a reminder, molarity is a measure of concentration using moles of substance per liter of solution. Mass percent is a measure of concentration using mass of substance per mass of solution, multiplied by 100. In this experiment, you will be introduced to another way of describing solution concentration:

**Parts-Per Notation:** Parts-per notations are used to express measurements of very small quantities. Some of the most commonly known are parts-per-million (ppm), and parts-per-billion (ppb). To calculate the concentration of a solution using ppm by mass, divide the mass of the solute by the mass of the total solution, and multiply the value by one million.

$$ppm \text{ (mass)} = \frac{m_{\text{solute}}}{m_{\text{total}}} \times 1,000,000$$

Just like **mass percent**, parts-per-million values are also dimensionless. It is therefore important to understand how a ppm value is derived. For example, in atmospheric sciences ppm may be calculated using the volumes of gases in the atmosphere (sometimes written as ppmv); whereas in toxicological studies, ppm is often calculated using mass. Ppm by mass may also be expressed as mg/kg (milligram per kilogram) to avoid confusion.

### Dilution Factor and Serial Dilution

In this experiment, you must prepare a large number of standard solutions. You should learn to perform dilution not just accurately, but also quickly. You have already learned how to use  $M_1V_1 = M_2V_2$  to calculate dilutions. Below is another, and often faster way to perform the same calculation.

It is possible to arrange the previous equation as the relationship between the ratio of the molar concentration and the inverse of the ratio of the volume:

$$\frac{M_1}{M_2} = \frac{V_2}{V_1}$$

This equation is often more useful when performing quick and simple dilutions.

For example, when diluting a 6 Molar solution to a 1 Molar solution, the total volume of the end solution should be six times the original:

$$\frac{M_1}{M_2} = \frac{6 \text{ Molar}}{1 \text{ Molar}} = \frac{V_2}{V_1} = \frac{30 \text{ mL}}{5 \text{ mL}}$$

Therefore, if you start with 5 mL of the 6 Molar solution, you should have 30 mL of the 1 Molar solution at the end. Alternatively, if your dilution results in a six-fold increase in volume, then you know the concentration of the solution is now 1/6 of the original.

The value of  $M_1/M_2$  is called the **dilution factor**, and a dilution process with a dilution factor of 2 is a **two-fold dilution**. In this experiment, you must perform a five-fold dilution of a buffer solution, i.e. to dilute a stock solution so that the final concentration is 1/5 (20%) that of the original.

### Serial Dilutions

A set of solutions with different, but accurately measured concentration is needed to construct a Beer's Law plot. An easy way to prepare these solutions is to use **serial dilution**, a sequence of stepwise dilutions with the same dilution factor.

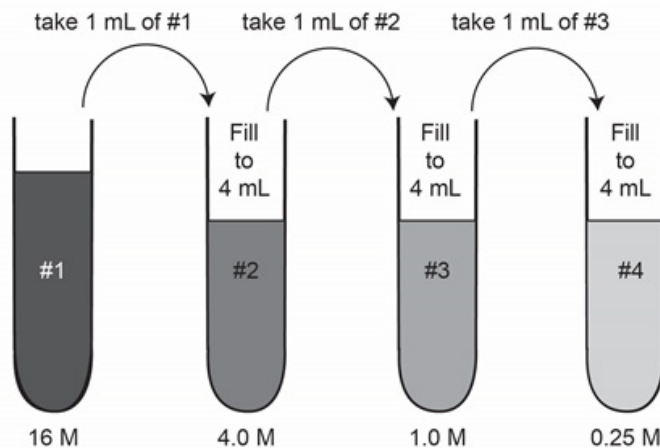

Shown above is an example of a 4-fold serial dilution. To perform serial dilutions, only the first step uses the stock solution. Every subsequent step uses an aliquot of solution drawn from the previously prepared solution.

### Parallel Dilutions

Serial dilutions are generated using the same dilution factor, with subsequent solutions made by aliquoting a set volume from the previously prepared solution. In comparison, **parallel dilutions**

are generated by aliquoting only from the original stock solution, and diluting it with increasing dilution factors.

In this experiment, you will be performing both serial and parallel dilutions.

### Dilution Techniques

Use only volumetric glassware for precise volume measurements. They are very carefully made to ensure precision, and thus very expensive. You will only have one of each type of volumetric glassware to use per group. When you finish preparing a solution using a volumetric flask, transfer the solution you just prepared into a test tube or another container, clean the flask and use it again for the next dilution.

If you are out of practice with the volumetric pipets, read the instructions on how to use them in the appendix of this manual or consult your lab instructor.

The neck of a volumetric flask holds less than 5% of the total volume. To avoid overfilling the flask, always use a DI water bottle, or a disposable transfer pipet to add the last bit of water to the graduation mark.

Do not use pipets to draw solutions from a volumetric flask. Always transfer the solution to another container first (e.g. a beaker or an Erlenmeyer flask).

### Experiment Overview

This experiment is designed to be completed in two weeks. You will be investigating the light-absorbing properties of two commonly used food dyes: Tartrazine (a.k.a. FD&C Yellow 5), and Allura Red AC (a.k.a. FD&C Red 40). We will refer to the dyes as TZ and AR for convenience. Remember that these are abbreviations and not chemical formulas.

In the first week, you will prepare a set of standard solutions for TZ and AR at different concentrations. A spectrum scan of both TZ and AR should be acquired for the most concentrated standard solutions, and used to identify the absorption maxima for TZ and for AR. The **absorption maxima** ( $\lambda_{\text{max}}$ ) is the wavelength of light that a compound absorbs the most.

Collect the absorbance readings for all TZ standard solutions at 430 nm. Use this data to construct a Beer's Law plot to calculate the effective molar absorptivity for TZ ( $\epsilon^{*TZ}_{430 \text{ nm}}$ ), at that the absorption maxima wavelength. As a reminder, the **effective molar absorptivity** ( $\epsilon^*$ ) is equal to molar absorptivity multiplied by path length. Using the Beer's Law plot and the value of  $\epsilon^{*TZ}_{430 \text{ nm}}$ , test and calculate the concentration of TZ in an unknown.

In the second week, you will continue to acquire absorbance readings for all TZ and AR standard solutions at the wavelengths of 430 nm and 480 nm. Using the Beer's Law plot and the values of four extinction coefficients ( $\epsilon^{*TZ}_{430 \text{ nm}}$ ,  $\epsilon^{*TZ}_{480 \text{ nm}}$ ,  $\epsilon^{*AR}_{430 \text{ nm}}$ ,  $\epsilon^{*AR}_{480 \text{ nm}}$ ), test and calculate the concentration of TZ and AR in a mixture.

### Notations of absorbance measurements

In this experiment, you will be taking a lot of different readings. The absorbance readings will be described in the manual in this format:

$$A_{\text{wavelength}}^{\text{solution identity}}$$

For example:

$A_{500 \text{ nm}}^{\text{AR}\#1}$  is the absorbance reading for AR solution #1 at wavelength 500 nm.

$A_{630 \text{ nm}}^{\text{TZ}}$  is the absorbance reading of some TZ solution at wavelength 630 nm.

### Dyed, delicious, dangerous?

Long before government administrations regulated the use of food colorants, people sometimes used toxic and carcinogenic compounds to color food products. For certain compounds, little was understood about the health issues they caused, and long-term studies were not available to track their effects. For other compounds, acute toxicity may be obvious, but it was difficult to hold manufacturers accountable for the illness or death of a consumer. Even if the health effects of these compounds were known, analytical testing was not widely available to test products for the presence of dangerous chemicals. Some historically used toxic food colorants are listed below.

In the United States, it wasn't until the government passed the "Pure Food and Drug Act of 1906" that manufacturing or selling poisonous food became illegal. Today, only 9 synthetic colorants are approved by the U.S. Food and Drug Administration for use in foods, although many naturally-derived colorants are also available.

Historically used toxic food colorants and their health effects:

**Coppersulfate ( $\text{Cu}_2\text{SO}_4$ ):** used to make pickles and olives greener. Health effects include gastrointestinal bleeding, liver inflammation, kidney failure and death.

**Copper arsenite ( $\text{CuHAsO}_3$ ):** used to color used tea leaves. Acute exposure can lead to vomiting, abdominal pain, and bloody stool. Chronic exposure can lead to thickening of the skin, heart disease, numbness, and cancer.

**Lead oxide ( $\text{Pb}_3\text{O}_4$ ):** used in confectionery and cheeses. Red lead can cause lead poisoning, which is characterized by blurred vision, irritability, a grayish facial hue, anemia, infertility, seizures, coma, and death.

## Learning Goals

---

The following is a list of skills that you will use in this experiment.

<b>Laboratory</b>	<ul style="list-style-type: none"><li>• Using volumetric flasks and pipets</li><li>• Performing serial and parallel dilutions</li><li>• Using a spectrophotometer</li></ul>
<b>Conceptual</b>	<ul style="list-style-type: none"><li>• Basic principles of spectrophotometry</li><li>• Beer's Law (<math>A = \epsilon \ell C</math>)</li><li>• Molarity vs. molality vs. mass percent vs. ppm</li></ul>
<b>Data Analysis</b>	<ul style="list-style-type: none"><li>• Calculating dilution factors</li><li>• Constructing a Beer's Law plot</li><li>• Calculating concentration from a Beer's Law plot</li></ul>

## Procedure

---

**Work in pairs** on this experiment.

The actual data analyses and the written reports must be done entirely independently of your lab partner or other students. Make sure that you avoid unauthorized collaboration and plagiarism. All suspected violations of the Code of Academic Conduct will be referred to Student Judicial Affairs.

### Stock Chemicals Used

Chemical	Usage per group
Tartrazine (TZ) stock solution	15 mL
Allura Red AC (AR) stock solution	15 mL
pH 8 buffer solution	20 mL
Tartrazine unknown	2 mL
Mixture unknown	2 mL

### Part I. CONSTRUCTION OF A STANDARD BEER'S LAW PLOT

#### A. Instrument Start-up

1. Familiarize yourself with the operations of the VSPEC spectrometer and the LabQuest 2 data collection device.

You can find step-by-step instructions in the previous chapter, *A Brief Introduction to Spectrophotometry*.

2. Create a new data file and discard any old data.

#### B. Solution Preparations

3. Acquire from your TA a set of 5 mL & 10 mL volumetric flasks, and a set of 1 mL and 5 mL volumetric pipets. **Be sure to return these to your TA by the end of lab.**

Also acquire from your TA 12 clean cuvettes. You will use the same set of cuvettes in Part I and II of this lab.

#### C. Dilution of pH 8.0 Buffer

4. Prepare 100 mL of working pH 8.0 buffer from a concentrated stock solution.

Transfer 20 mL of concentrated pH 8.0 buffer into a clean 125 mL Erlenmeyer flask and add DI water to a total volume of 100 mL.

### Safety First

---

Treat the spectrophotometers with great care as they are expensive and delicate.

Wear your goggles.

### Hint

---

Practice using both  $M_1/M_2 = V_2/V_1$  and  $M_1V_1 = M_2V_2$  and use the form that works for you.

#### D. Parallel Dilutions of Tartrazine (TZ)

5. Prepare the five Tartrazine (TZ) absorbance standards needed to construct the Beer's plot. The concentrations of the standards should be **20 %, 40 %, 60 %, 80 % and 100 %** the concentration of the stock solution provided to you. Mark the frosted label on the test tubes with a pencil to note the concentration of each solution.

Fill a beaker with approximately 15 mL of stock TZ. Do not use more than necessary. Record the concentration of the stock solution.

You will be using a 1 mL volumetric pipet, a 5 mL volumetric flask, and a disposable transfer pipet. No extras allowed.

- Using volumetric glassware, transfer 1.00 mL of stock TZ solution to the 5 mL volumetric flask. Add pH 8 buffer to a final volume of 5.00 mL. Transfer the solution to a test tube. This is **TZ solution #5**.
- Using volumetric glassware, transfer 2.00 mL of stock TZ solution to the 5 mL volumetric flask. Add pH 8 buffer to a final volume of 5.00 mL. Transfer the solution to a test tube. This is **TZ solution #4**.
- Using volumetric glassware, transfer 2.00 mL of pH buffer solution to the 5 mL volumetric flask. Add stock TZ solution to a final volume of 5.00 mL. Transfer the solution to a test tube. This is **TZ solution #3**.
- Using volumetric glassware, transfer 1.00 mL of pH buffer solution to the 5 mL volumetric flask. Add stock TZ solution to a final volume of 5.00 mL. Transfer the solution to a test tube. This is **TZ solution #2**.
- Transfer the left-over stock TZ solution in a test tube. You should have at least 5 mL. This is **TZ solution #1**.

Answer the following questions before continuing further:

**Question A:** Record the molar concentration of the stock solution in your note book. What is the molar concentration of each TZ standard that you've prepared?

**Question B:** Why is it important to use volumetric glassware for the dilutions?

#### E. Serial Dilutions of Allura Red AC (AR)

6. Prepare the five Allura Red AC (AR) absorbance standards needed to construct the Beer's plot by serial dilution using the stock solution provided to you. Mark the frosted label on the test tubes with a pencil to note the dilution factor of each solution.

Fill a beaker with approximately 15 mL of stock AR solution. Do not get more than necessary. Record its concentration.



You will be using a 5 mL volumetric pipet and a 10 mL volumetric flask. No extras allowed.

- a. Using volumetric glassware, transfer 5.00 mL of stock AR solution to the 10 mL volumetric flask. Add pH 8 buffer to a final volume of 10.00 mL. Transfer this solution to a test tube. This is **AR solution #2**.
  - b. Using volumetric glassware, transfer 5.00 mL of the solution you prepared from step 6a. to the 10 mL volumetric flask. Add pH 8 buffer to a final volume of 10.00 mL. Transfer the solution to a test tube. This is **AR solution #3**.
  - c. Using volumetric glassware, transfer 5.00 mL of the solution you prepared from step 6b. to the 10 mL volumetric flask. Add pH 8 buffer to a final volume of 10.00 mL. Transfer the solution to a test tube. **This is AR solution #4**.
  - d. Using volumetric glassware, transfer 5.00 mL of the solution you prepared from step 6c. to the 10 mL volumetric flask. Add pH 8 buffer to a final volume of 10.00 mL. Transfer the solution to a test tube. **This is AR solution #5**.
  - e. Store the left-over stock AR solution in a test tube. You should have at least 5 mL. **This is AR solution #1**.
7. Clean and return the 5 mL and 10 mL volumetric flasks to your TA.

Answer the following questions before continuing further:

**Question C:** Record the concentration of the AR stock solution in your note book. The concentration is given to you in **ppm by mass** (mg/kg).

Assuming that the density of water is 1.00 g/mL, calculate the molar concentration of the stock solution and the molar concentration of each dilution of AR that you've prepared.

**Question D:** Why is it important to use volumetric glassware for the dilutions?

**Question E:** What are the advantages and disadvantages of serial dilution?

### F. Spectral Scans of Allura Red AC and Tartrazine

8. Prepare the blank cuvette and sample cuvettes. Fill the cuvette to just above the sample area line, or approximately 1 ml of solution.
  - a. Fill a cuvette with dilute pH 8.0 phosphate buffer as the blank.
  - b. Fill a second cuvette with TZ standard #1 from your test tube.
  - c. Fill a third cuvette with AR standard #1 from your test tube.
9. Following the instructions on **Measuring the Full Spectrum Absorbance of a Sample** in *Introduction to Spectrophotometry*, perform a

### Hint

---

Remember to use the pH 8.0 phosphate buffer for the blank to calibrate the spectrometer before collecting data.

full spectrum scan of the absorbance readings of the TZ standard #1 and AR standard #1.

In your lab notebook, record the absorbance data for TZ#1 and AR#1 from 400 nm to 600 nm in 10 nm increments. Identify  $\lambda_{\text{max}}$ , the wavelength at which the absorbance reading is the highest.

Answer the following question before continuing further:

**Question F:** Why is the dilute pH 8 buffer used as the blank and not DI water?

**Question G:** What does each graph represent? The answer to this question will prepare you for Part II of this laboratory next week. Include an answer to this question in your Post-laboratory conclusion statement.

### G. Measuring Absorbance of an Unknown TZ Solution

10. Following the instructions in *Introduction to Spectrophotometry*, measure the absorbance of TZ standards #1–5 at 430 nm. Record the absorbance readings in your notebook. This data will be used to create a Beer's Law plot.

11. Your TA will assign you a TZ solution of unknown concentration. Record the identity of the unknown in your notebook.

Obtain enough TZ solution to fill a cuvette. Measure and record the absorbance reading of the unknown at 430 nm.

### ► Save your 10 samples and your buffer for Part II!

#### Clean-Up:

- Turn off the LabQuest and remove any cuvettes left in the sample compartment of the spectrometer. Make sure everything is returned to the correct storage bin.
- Clean and return to your TA the volumetric flasks (5 mL and 10 mL) and pipets (1 mL and 5 mL) that you checked out, if you have not yet done so.
- Pour the content of the cuvettes down the sink. Clean the used cuvettes thoroughly with DI water using a squeeze bottle and leave them in your locker to dry.
- Secure the 10 samples in test tubes by parafilming the tops.
- Save the dilute pH 8 buffer in a 1 L bottle.

### Hint

Remember to use the pH 8.0 phosphate buffer for the blank to calibrate the spectrometer before collecting data.

### H. Construct the Beer's Law Plot for Tartrazine Standard Solutions

12. Reminder: After the laboratory, use the data recorded in your notebook to make a clear plot using Excel. Include the best-fit line for your data that goes through the origin.

Find the slope of your graph. Using 1.0 cm for  $\ell$ , calculate the value of  $\epsilon$  in units of  $\mu\text{M}^{-1}\cdot\text{cm}^{-1}$ .

Determine the concentration of the unknown solution of TZ by using the Beer's Law plot and the measured concentration.

This data will be used in next week's experiment.

## Part II. SPECTRAL ASSIGNMENTS

**Hint**

Remember to use the pH 8.0 phosphate buffer for the blank to calibrate the spectrometer before collecting data.

**Hint**

Using the format

$$A_{\text{wavelength}}^{\text{dye\&concentration}}$$

list the 20 readings you should have recorded in your note book.

For example:

$$A_{400\text{ nm}}^{0.6\ \mu\text{M AR}} = 0.25$$

**A. Using Beer's Law Plots to Determine the Concentrations of an Unknown Mixture**

- Following the instructions on **Measuring Absorbance vs. Concentration (Beer's Law)** in *Introduction to Spectrophotometry*, measure and record the following absorbance readings in your notebook:
  - TZ standards #1–5 at 480 nm ( $A_{480\text{ nm}}^{\text{TZ}}$ )
  - AR standards #1–5 at 430 nm ( $A_{430\text{ nm}}^{\text{AR}}$ )
  - AR standards #1–5 at 480 nm ( $A_{480\text{ nm}}^{\text{AR}}$ )

When finished, you should have collected a total of 20 readings, including the TZ standards #1-5 at 430 nm ( $A_{430\text{ nm}}^{\text{TZ}}$ ) from Part I.

**B. Unknown Preparation**

- The TA will provide you with 3 mL of an unknown. The unknown contains a mixture of TZ and AR. You will not receive extras so be careful with it!

**C. Scan the Unknown Mixture**

- Following the instructions on **Measuring the Full Spectrum Absorbance of a Sample** in *Introduction to Spectrophotometry*, perform a full spectrum scan of the absorbance readings of the unknown.

Record the absorbance data from 400 nm to 600 nm in 10 nm increments in your notebook. Note and record the wavelength of all absorbance peaks on the graph.

**Clean-Up:**

- Turn off the LabQuest and remove any cuvette left in the sample compartment of the spectrometer.
- Pour the content of the cuvettes down the sink and clean the used cuvettes thoroughly with DI water. Dispose of the cuvettes in the trash.
- Clean and return to your TA the volumetric flasks (5 mL and 10 mL) and pipets (1 mL and 5 mL) that you checked out.

Answer the following question before leaving the laboratory:

**Question H:** What do the two peaks in the plot of Absorbance vs. Wavelength represent? Include an answer to this question in your Post-laboratory conclusion statement.

## Part I. Data Analysis

---

### Preparation of Tartrazine (TZ) Solutions by Parallel Dilution

1. What is the concentration of the TZ stock solution (also known as TZ #1) in  $\mu\text{M}$  (micromolar)? This is your most concentrated (undiluted) standard solution for which you measured the absorbance.
2. Report the precise volume (in milliliters) of TZ #1 used to prepare TZ standard solution #2 (TZ #2).
3. You diluted a portion of TZ #1 with the pH 8.0 buffer to make TZ #2. Report the final volume of the resulting TZ #2 you prepared.
4. Calculate the molarity of TZ #2 in  $\mu\text{M}$ . The concentration can be found according to the formula (1) in the introduction. Remember that  $M_1$  will be the concentration of TZ #1, and  $V_1$  is the volume of TZ #1 added.  $V_2$  is the total volume of the diluted solution.
5. Report the precise volume (in milliliters) of TZ #1 used to prepare TZ standard solution #3 (TZ #3).
6. You diluted a portion of TZ #1 with the pH 8.0 buffer to make TZ #3. Report the final volume of the resulting TZ #3 you prepared.
7. Calculate the molarity of TZ #3 in  $\mu\text{M}$ .
8. Report the precise volume (in milliliters) of TZ #1 used to prepare TZ standard solution #4 (TZ #4).
9. You diluted a portion of TZ #1 with the pH 8.0 buffer to make TZ #4. Report the final volume of the resulting TZ #4 you prepared.
10. Calculate the molarity of TZ #4 in  $\mu\text{M}$ .
11. Report the precise volume (in milliliters) of TZ #1 used to prepare TZ standard solution #5 (TZ #5).
12. You diluted a portion of TZ #1 with the pH 8.0 buffer to make TZ #5. Report the final volume of the resulting TZ #5 you prepared.
13. Calculate the molarity of TZ #5 in  $\mu\text{M}$ .

### Preparation of Allura Red AC (AR) Solutions by Serial Dilution

1. What is the concentration of the AR stock solution (also known as AR #1) in ppm? Remember, to calculate the concentration of a solution in ppm using mass, divide the mass of the solute by the mass of the total solution, and multiple the value by one million. This is your most concentrated undiluted standard solution for which you measured the absorbance.

- Using the molar mass of AR (496.42 g/mol), and that 1 ppm = 1 mg/L, convert this ppm concentration to  $\mu\text{M}$ . Assume the density of the solution is 1.000 g/mL.
- Report the precise volume (in milliliters) of AR #1 used to prepare AR standard solution #2 (AR #2).
- You diluted a portion of the AR #1 with the pH 8.0 buffer to make AR #2. Report the final volume of the resulting AR #2 you prepared.
- Calculate the molarity of AR #2. The concentration can be found according to the formula (1) in the introduction. Remember that  $M_1$  will be the concentration of AR #1, and  $V_1$  is the volume of AR #1 added.  $V_2$  is the total volume of the diluted solution.
- Report the precise volume (in milliliters) of AR #2 used to prepare AR standard solution #3 (AR #3).
- You diluted a portion of the AR #2 with the pH 8.0 buffer to make AR #3. Report the final volume of the resulting AR #3 you prepared.
- Calculate the molarity of AR #3. For this calculation,  $M_1$  will be the concentration of AR #2, and  $V_1$  is the volume of AR #2 added.  $V_2$  is the total volume of the diluted solution.
- Report the precise volume (in milliliters) of AR #3 used to prepare AR standard solution #4 (AR #4).
- You diluted a portion of the AR #3 with the pH 8.0 buffer to make AR #4. Report the final volume of the resulting AR #4 you prepared.
- Calculate the molarity of AR #4. For this calculation,  $M_1$  will be the concentration of AR #3, and  $V_1$  is the volume of AR #3 added.  $V_2$  is the total volume of the diluted solution.
- Report the precise volume (in milliliters) of AR #4 used to prepare AR standard solution #5 (AR #5).
- You diluted a portion of the AR #4 with the pH 8.0 buffer to make AR #5. Report the final volume of the resulting AR #5 you prepared.
- Calculate the molarity of AR #5. For this calculation,  $M_1$  will be the concentration of AR #4, and  $V_1$  is the volume of AR #4 added.  $V_2$  is the total volume of the diluted solution.

### **Measuring the Absorbance of TZ Solutions of Known & Unknown Concentration**

- Why do we allow electronic instruments to warm-up before use?
- Why is it important not to have fingerprints on the cuvette?

3. Why is it important to align the cuvette in the sample holder the same way each time?

### Constructing the Beer's Law Plot

1. Please enter each of the respective TZ solution concentrations that you have already calculated, and that solution's absorbance at 430 nm. The absorbance values are obtained directly from the spectrometer and should have a value between 0 and 2.
2. Using spreadsheet software such as Excel, plot absorbance versus concentration ( $\mu\text{M}$ ) of TZ at 430 nm. Add a linear trend line that has an intercept set to 0, and determine the slope of the linear trend line. This is known as a Beer's Law plot, the expression for which is  $A = \epsilon^*C$ , where  $A$  is the absorbance (unitless),  $C$  is the concentration, and  $\epsilon^*$  is the effective molar absorptivity (represented by the slope of the linear trend line), which has units of  $\text{L}/\mu\text{mol}$  in this case.
3. Using the Beer's Law plot constructed for TZ at 430 nm, please report the effective molar absorptivity ( $\epsilon^*$ ,  $\text{L}/\mu\text{mol}$ ), which is the slope of the linear trend line through the data.
4. Report the absorbance reading obtained for your assigned TZ unknown at 430 nm. Using the calculated effective molar absorptivity ( $\epsilon^*$ ) of TZ from the Beer's Law plot you already generated, calculate the concentration of your TZ unknown.

## Part II. Data Analysis

---

In the Data Analysis portion of this experiment, we will distinguish between Allura Red AC and Tartrazine using the following symbols in the equations:

AR = Allura Red AC

TZ = Tartrazine

We will distinguish the four different  $\epsilon^*$  values by the subscripts listed below:

$\epsilon_{430\text{ nm}}^{*\text{AR}}$  = AR solution examined at the wavelength of 430 nm

$\epsilon_{480\text{ nm}}^{*\text{AR}}$  = AR solution examined at the wavelength of 480 nm

$\epsilon_{430\text{ nm}}^{*\text{TZ}}$  = TZ solution examined at the wavelength of 430 nm

$\epsilon_{480\text{ nm}}^{*\text{TZ}}$  = TZ solution examined at the wavelength of 480 nm

### Measuring the Absorbance of TZ #1-5 and AR #1-5 at 430 and 480 nm.

1. Please enter the concentrations and corresponding absorbances of TZ #1-5 at 480 nm; AR #1-5 at 430nm; and AR #1-5 at 480 nm. The absorbance values are obtained directly from the spectrometer and should have a value between 0 and 2.
2. Using spreadsheet software such as Excel, generate Beer's Law plots of absorbance versus concentration ( $\mu\text{M}$ ) for TZ #1-5 at 480 nm; AR #1-5 at 430nm; and AR #1-5 at 480 nm. Add a linear trend line that has an intercept set to 0, and determine the slope of the linear trend line. This is known as a Beer's Law plot, the expression for which is  $A = \epsilon^* C$ , where  $A$  is the absorbance (unitless),  $C$  is the concentration, and  $\epsilon^*$  is the effective molar absorptivity (represented by the slope of the linear trend line), which has units of  $\text{L}/\mu\text{mol}$  in this case.
3. Using the Beer's Law plots constructed for TZ and AR at 430 and 480 nm (including the one you previously constructed for Data Analysis Part I), please report the respective effective molar absorptivity ( $\epsilon^*$ ,  $\text{L}/\mu\text{mol}$ ), which is represented the slope of the linear trend line through the data on each plot.

### Measuring the Absorbance of an Unknown Mixture

The absorbance of a mixture of absorbing species which do not interact with each other in any way is the **sum of the individual absorbances of each of the species**.

Tartrazine and Allura Red do not react with one another in solution. Therefore, in a solution that contains both AR and TZ compounds in significant amounts, the absorbance of the mixture at 430 nm will be given by the equation

$$A_{430\text{ nm}} = \epsilon_{430\text{ nm}}^{*\text{AR}}[\text{AR}] + \epsilon_{430\text{ nm}}^{*\text{TZ}}[\text{TZ}]$$

and the absorbance at 480 nm will be given by the equation

$$A_{480\text{ nm}} = \epsilon_{480\text{ nm}}^{*\text{AR}}[\text{AR}] + \epsilon_{480\text{ nm}}^{*\text{TZ}}[\text{TZ}]$$



where  $[AR]$  is the molar concentration of AR, and  $[TZ]$  is the molar concentration of TZ.

After substituting the four  $\epsilon^*$  values determined from the Beer's Law plots and the two absorbances of the unknown mixture measured at 430 nm and 480 nm, we can solve for the concentrations  $[TZ]$  and  $[AR]$  in the **2×2 system of linear equations**.

- What was the absorbance of your unknown mixture at 430 and 480 nm? Using the absorbance readings at each of these wavelengths, calculate the concentrations of TZ and AR in your unknown mixture.

**C. Turn in plots (4 total)**



# Determination of Avogadro's Number

## Introduction

---

In this experiment, you will use information derived from the electrolytic decomposition of water to determine the numerical value of **Avogadro's number** ( $N_A$ ),  $6.02214076 \times 10^{23}$ . As you may remember, this quantity is defined as the number of atoms in exactly twelve grams of isotopically-pure  $^{12}\text{C}$ .

The atomic mass of  $^1\text{H}$  is 1.00780 **atomic mass units (amu)**. One amu is equal to  $\frac{1}{12}$  the mass of a carbon-12 atom, approximately  $1.66 \times 10^{-27}$ . The tabulated atomic masses of elements, which are often also loosely called their atomic weights, are dimensionless, abundance-weighted, averages of the atomic masses of the various isotopes that make up a naturally occurring macroscopic sample of the element in question.

A mole of a substance is equal to an Avogadro's number of its constituent units (i.e. atoms, molecules). As a result, the mass of one mole of a substance in grams is numerically equal to the sum of the atomic weights of all of its elemental components. The **molar mass** of a substance (often termed its molecular weight) has the same numerical value both in atomic mass units and in grams/mole. Thus, the number of moles of a molecular substance can be obtained by dividing the mass of the sample by the molar mass of the molecule.

If the substance in question is a gas, then pressure-volume-temperature (P-V-T) measurements can also be used to determine the number of moles of gas in a sample if its Equation of State is known. In this experiment we will assume that the Ideal Gas Law applies.

When two chemically inert electrodes are immersed in water and a sufficiently high DC voltage is applied across them, an electric current is observed to flow and gases are evolved at both electrodes. Chemical tests show that one of the gases is molecular hydrogen and the other is molecular oxygen. The overall process is termed "**electrolysis**." (The noun "*lysis*" derives from the Greek word for disintegration.) A fairly straightforward way to think about the electrolysis experiment is as follows:

The "negative" pole of a battery looks negative because there are surplus electrons being made available there as a result of chemical reactions within the battery itself. The positive pole of a battery, on the other hand, is electron deficient.

When both battery terminals are connected to electrodes immersed in the solution, the internal reactions within the battery will continuously replenish the electron surplus at the negative side and generate an electron deficiency at the positive side, leading to ongoing chemical processes at the two electrodes. If water is the chemical substance being electrolyzed, the two electrode processes are:

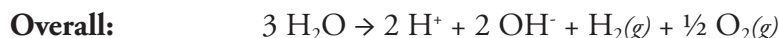

## Determination of Avogadro's Number

(Note that as with all chemical reactions, the two electrode reactions are both balanced by mass and charge.)

If the solution is disturbed, the  $\text{H}^+$  and  $\text{OH}^-$  products that accumulate near the two electrodes will react with each other to make water again. The net effect of the electrolysis is to turn 3 moles of water into one mole of hydrogen gas and half a mole of oxygen gas for every two moles of electrons transferred around the circuit in the form of an electric current.

The number of moles of gas produced is directly related to the number of electrons transferred around the circuit. Thus,  $N_A$  can be determined by counting the numbers of electrons transferred from one electrode to the other, and measuring the number of moles of either hydrogen gas or oxygen gas that accompanies the electron transfer. The chemical product is easily quantified by collecting and measuring the volume of gas formed together with its pressure and temperature.

The number of electrons concurrently transferred is equally easy to measure. The customary unit of electric current is called the **Ampere**. One Ampere of current flow corresponds to the passage of one **Coulomb** of electrical charge through the circuit in a one-second time interval; in other words,

$$\text{Amperes} = \frac{\text{Coulombs}}{\text{seconds}}$$

The charge on one electron is approximately  $1.602176634 \times 10^{-19}$  coulombs.

The Coulombic charge on an electron is known from independent physical measurements. Therefore, the quantity of electrons transferred can be determined by measuring the current in Amperes, multiplying it by the time in seconds during which the current flows, and dividing the resulting product by the charge of one electron. (More precisely, one should calculate the integral of current with respect to time over the course of the experiment. However, this is outside the scope of this course.)

### Calculating Avogadro's Number

By the end of this experiment, you will have collected data for the volume of evolved hydrogen gas and the current vs. time profile for its evolution. In order to calculate  $N_A$ , you will need to compute the number of moles of evolved hydrogen and the number of electrons that were transferred during its evolution.

The first thing you will want to calculate is the number of electrons transferred, since it is relatively easy to obtain. Begin this calculation by determining the average value of the current along with its standard deviation.

Next, multiply the average current by the total electrolysis time (in seconds) to obtain the number of Coulombs passed through the solution during the electrolysis. The resulting product must have the same relative standard

deviation as the corresponding quantity for the current itself. In other words, if the current is uncertain by 5% then the Coulombs passed must also be uncertain by 5%. (This statement assumes that there is no significant error in the time measurement.)

If you then divide the number of Coulombs transferred by the charge on an electron,  $1.602176634 \times 10^{-19}$  Coulombs, you will get the number of electrons transferred. Again, the relative error in the number of electrons involved in the electrolysis must be the same as that in the current from which it was calculated.

At the end of the experiment, the buret contains hydrogen and water vapor. You can determine the amounts of each vapor that is initially present. The calculation is the same. As in the previous experiment, the pressure outside the system must be equal to the pressure inside the system. Therefore, the sum of the partial pressures of water vapor and hydrogen gas plus the pressure exerted by the column of water in the buret must be equal to the outside atmospheric pressure.

$$P_{H_2} = P_{bar} - (P_{H_2O} + P_h)$$

The partial pressure of hydrogen in the buret at the end of the experiment is given by the total barometric pressure minus the sum of the pressure exerted by the column of water in the buret and the vapor pressure of water. Remember that the vapor pressure of water is dependent on temperature. The values for a range of temperatures are given in Table 2.

The number of moles of hydrogen produced in the electrolysis can now be calculated from the Ideal Gas Law, with "P" equal to its partial pressure and "V" equal to the total gas volume at the end of the electrolysis.

With the number of moles of hydrogen produced and the number of electrons accompanying its production both in hand,  $N_A$  is readily calculated. The relative standard deviation of your calculated value of  $N_A$  may be taken to be the same as that of the current measurements.

Even if the observed current did not change at all over the course of the experiment, it would nevertheless have a standard deviation of at least  $\pm 0.001$  Ampere due to the limited accuracy of the instrument.

## Determination of Avogadro's Number

**Table 1:**

**The volume occupied by 1.0000 g water weighed in air against stainless steel weights.**

Temperature (°C)	Volume (mL)
18	1.0024
19	1.0026
20	1.0028
21	1.0030
22	1.0033
23	1.0035
24	1.0037
25	1.0040
26	1.0043

**Table 2:**

**Vapor Pressure of Water at Different Temperatures**

Temperature (°C)	Vapor Pressure (mm Hg)	Temperature (°C)	Vapor Pressure (mm Hg)
15	12.8	23	21.1
16	13.6	24	22.4
17	14.5	25	23.8
18	15.5	26	25.2
19	16.5	27	26.7
20	17.5	28	28.3
21	18.6	29	30.0
22	19.8	30	31.8

### How big is Avogadro's number?

Avogadro's number,  $6.02214076 \times 10^{23}$ , is almost too large to comprehend. To make visualizing this value easier, here is an "Avogadro's number" of items to help you grasp its enormity:

If the average volume of a grain of sand is  $0.5 \text{ mm}^3$ , an Avogadro's number of sand would have a volume of  $301,107 \text{ km}^3$ .

Currently there are 7.753 billion people on the planet, and the average life expectancy is 26,517 days. If an Avogadro's number of money was divided among everyone, each person could spend approximately \$2.9 billion a day.

The distance across our Milky Way galaxy is about  $1.0 \times 10^{21} \text{ m}$ . To travel an Avogadro's number of meters, you would have to cross the Milky Way a little over 602 times.

An Avogadro's number of water molecules has a mass of 18.01528 g.

## Learning Goals

---

---

<b>Laboratory</b>	<ul style="list-style-type: none"><li>• Using a power supply and multimeter</li><li>• Reading a buret</li></ul>
<b>Conceptual</b>	<ul style="list-style-type: none"><li>• Avogadro's number</li><li>• Electrolysis of water</li><li>• Ideal Gas Law</li><li>• Dalton's Law</li></ul>
<b>Data Analysis</b>	<ul style="list-style-type: none"><li>• Using <math>PV=nRT</math> to calculate moles of gas</li><li>• Using <math>Q=Ixt</math> to calculate number of electrons</li><li>• Deriving Avogadro's number</li></ul>

## Procedure

---

You will **work in pairs** on this experiment. The actual data analyses and the written reports must be done entirely independently of your lab partner or other students.

The actual data analyses and the written reports must be done entirely independently of your lab partner or other students. Make sure that you avoid unauthorized collaboration and plagiarism. All suspected violations of the Code of Academic Conduct will be referred to Student Judicial Affairs.

### Stock Chemicals Used

Chemical	Maximum Amount Used
3 M Sulfuric Acid	<25 mL

### Quantitative Measurements

1. For this experiment you will need a 25 mL buret, a 100 mL beaker for water, a thermometer, a stainless steel spiral electrode, a graphite (carbon) electrode, your power supply and multimeter apparatus, and about 60 mL of 0.2 M sulfuric acid solution stored in a 150 mL beaker.
  - a. Check that your DC power supply is in good condition. Refer to Figure 1 on the next page for terminology and set up. If the clip leads are corroded or frayed, take them to the Dispensary to exchange for a new set.
  - b. Prepare 60 mL of 0.2 M sulfuric acid by diluting the 3 M sulfuric acid stock solution found at your lab bench.
  - c. Acquire the graphite electrode and stainless steel spiral electrode from your TA. Be careful with the electrodes and return them to your TA at the end of the lab in good condition.
  - d. You will be collecting gas into an inverted 25 mL buret. Thus, you must determine the volume of the uncalibrated portion of the buret between the 25 mL mark and stopcock.

Using the weigh-by-difference technique, find a way to determine the mass of water in the uncalibrated region of the buret. Report this mass to 3 decimal places. Finally, use the conversion factors in Table 1 of the introduction to calculate the volume.

### Hint

Remember that the water coming out of the tap is not necessarily at room temperature.



- ① Voltage display
- ② Current display
- ③ Negative (-) output terminal
- ④ Positive (+) output terminal
- ⑤ Illuminated On/Off switch
- ⑥ Current adjustment
- ⑦ Voltage adjustment

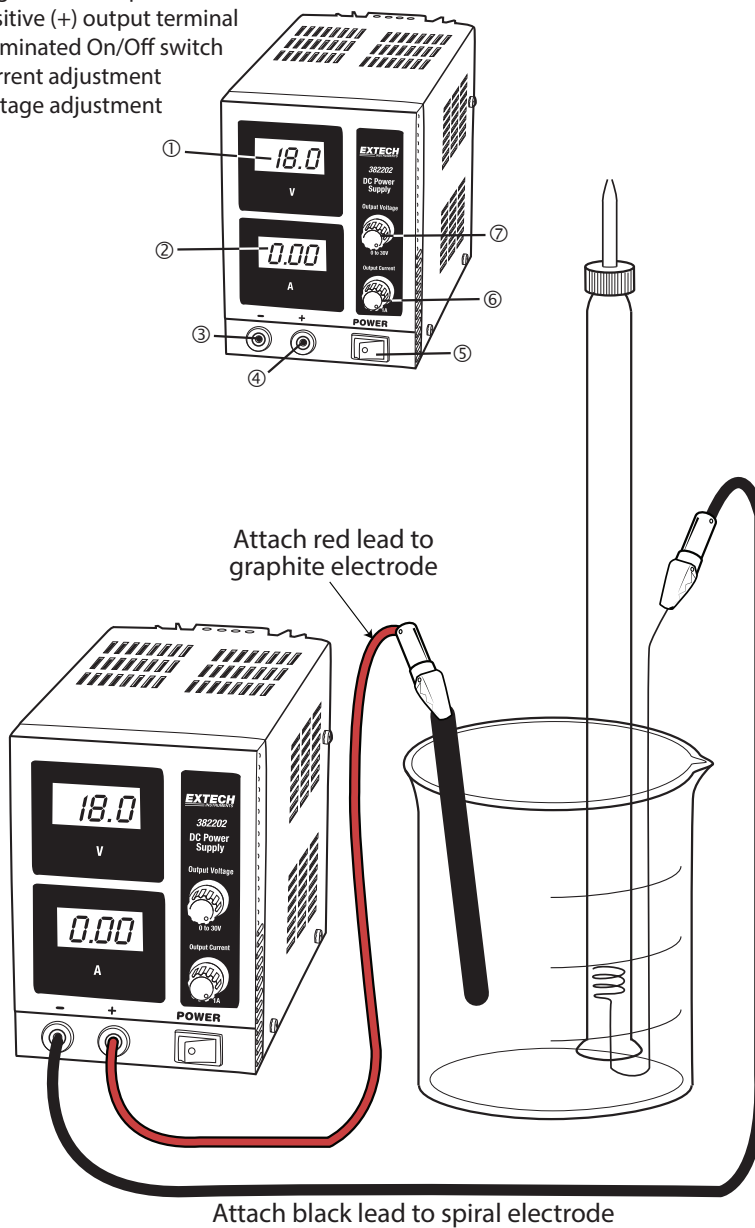
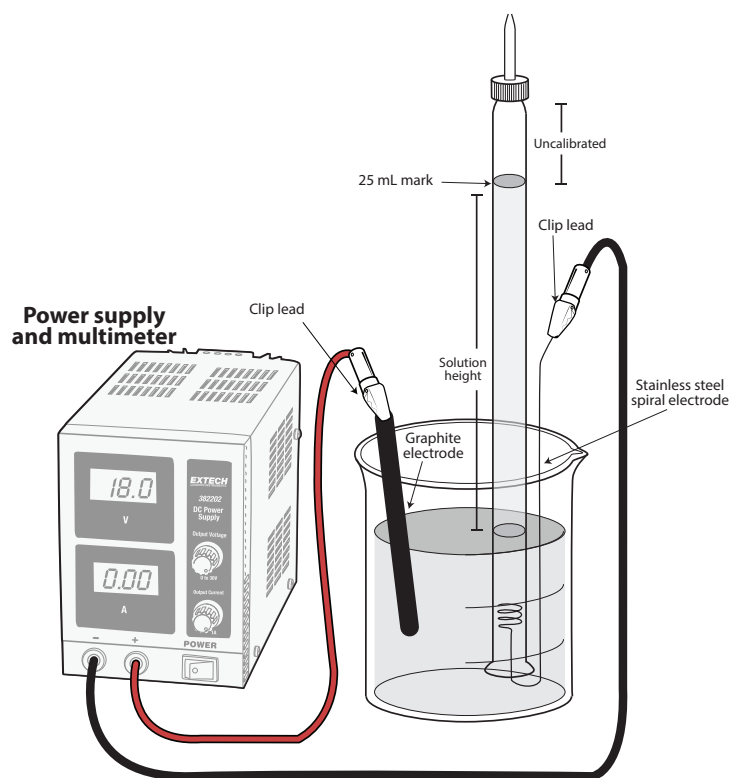

Figure 1. Schematic of the Power Supply/Meter and Lead Connectivity.



**Figure 2. Electrolysis Apparatus**

2. You will set up the electrolysis assembly to electrolyze water and collect hydrogen gas in your buret. Oxygen gas is generated at the graphite electrode and allowed to escape into the atmosphere. Figure 2 shows selected parts of the assembled apparatus as it should appear at the instant the electrolysis begins.
  - a. Invert the buret and insert the stainless steel coil electrode into the buret mouth. Lower the buret to the bottom of the beaker of diluted sulfuric acid, and then carefully clamp the inverted buret to a support rod.

Open the buret stopcock. With a rubber bulb, carefully draw the sulfuric acid solution up into the buret all the way to the top of the column. Then close the stopcock, leaving no air bubbles.
  - b. Record the barometric pressure using the barometer mounted on one of the walls in the laboratory room. Please do not touch any of the buttons on the barometer.

Answer this question before you continue with the experiment.

**Question A:** To which pole of the power supply should the electrode be connected in order to collect the hydrogen gas in the buret?

### **Safety First**

Be sure not to draw the sulfuric acid solution through the pipet tip and into the rubber bulb.

Be very careful when handling the buret from here on—the outside of the buret will have acid on it.

Do not get this acid on yourself or drip it onto the floor, lab bench, neighbors and so on!

- c. Connect the (-) terminal from the multimeter to the spiral electrode. Connect the (+) terminal from the multimeter to the graphite electrode. Be sure you are collecting the hydrogen gas at the spiral electrode! Do NOT put the graphite electrode into the solution in the beaker just yet. Refer to Figure 2.
3. Before you can collect data, you must calibrate the power supply settings.
    - a. Turn the power switch to the **ON** position. Adjust the voltage knob to the middle position. The voltage reading should be about 12 Volts. Do not adjust the voltage knob after this point.
    - b. Put the attached graphite electrode into the beaker as shown in Figure 2. Now adjust the current knob to get a reading of about 0.2 Amps.
    - c. Once your power supply has a stable reading of 0.2 Amps, your calibration of the electrolysis is complete. You will use the same setting for all part of this experiment, and there should be no further need for adjustments. Turn the power switch to the **OFF** position.  
Remove the graphite electrode from the solution, and place it in your clean beaker next to the buret.
    - d. Place a rubber bulb over the buret tip and open the buret stopcock. With the rubber bulb, carefully draw the sulfuric acid solution to the top of the column then close the stopcock, leaving no air bubbles.  
Because the hydrogen gas in the rubber bulb is flammable, you must **expel the gas in the fume hood**. As you take the rubber bulb off the buret, use your finger to seal the bulb's opening. Squeeze and release the bulb several times in the hood to expel any hydrogen gas.
  4. You will now begin your electrolysis.
    - a. Clip the graphite electrode to the clip lead and place the graphite electrode into the solution. Turn the power supply on again and begin your first determination.
    - b. Record the power supply meter reading every 60 seconds, including voltage and current. Turn off the power supply after a total of 10 minutes (10 readings) **OR** if the solution in the buret drops to below the 10 ml mark on the buret.  
Once the power has been turned off, remove the graphite electrode from the solution, thereby ending the electrolysis. Store the graphite electrode in your clean beaker until the next trial.
    - c. Wait a few minutes for all the hydrogen bubbles to rise to the top of the buret. Also inspect the turns of the stainless steel spiral to see if any gas bubbles are trapped there.

### Hint

---

The red lead coming off of the multimeter is the positive (+) pole and the black lead coming off of the black terminal is the negative (-) pole.

## Determination of Avogadro's Number

### Hint

---

Recall that one buret drop is about 0.05 mL, and it is unlikely that any of the trapped gas bubbles will be that big.

If there are some bubbles, you can tap the buret gently and try to dislodge them. If you cannot do so, try to estimate their number and sizes and consider the additional volume when you calculate the volume of  $\text{H}_2(g)$  produced.

- d. When no more hydrogen bubbles are visible in the liquid column, read and record the final buret reading.

Also, measure the height in millimeters of the liquid level in the buret above the liquid level in the beaker.

Be sure to take and record the temperature of the solution.

### Safety First

---

Be sure not to draw the sulfuric acid solution through the pipet tip and into the rubber bulb.

5. Reset your electrolysis set-up to prepare for the second trial.
  - a. Place a rubber bulb over the buret tip and open the buret stopcock. With the rubber bulb, carefully draw the sulfuric acid solution to the top of the column then close the stopcock, leaving no air bubbles.  
Because the hydrogen gas in the rubber bulb is flammable, you must **expel the gas in the fume hood**. As you take the rubber bulb off the buret, use your finger to seal the bulb's opening. Squeeze and release the bulb several times in the hood to expel any hydrogen gas.
  - b. Open the buret stopcock, allow the solution to flow back into the beaker, and close the stopcock. Swirl the beaker to homogenize the solution. You will now again use a rubber bulb to raise the solution level to the top of the column.

6. You are now ready to start your second trial by repeating Step 4.
- a. In this repetition, you should use a different (measured!) collection time. It is up to you to decide whether to use a longer or shorter time depending on the amount of gas evolved in 10 minutes.

You do not want to have an evolved volume that is too small because the accuracy of your final answer depends on how big that volume is.

However, you should not run the electrolysis for too long either, since as the electrolysis proceeds the solution compositions change near the electrodes and the current could vary somewhat erratically.

- b. At the end of the second run, again use the rubber bulb to collect the hydrogen gas and expel it in the hood by repeating Step 5a.
7. Perform a total of 3 trials of electrolysis.

**Hint**

---

Remember what happened in the two funnels in Part A of this experiment.

**Clean-Up:**

- While wearing gloves, remove the spiral electrode and place it in your clean beaker along with the graphite electrode. Rinse out the buret, wash off the electrodes with deionized water, and return everything to its proper place. Do not throw out the graphite electrodes.
- Slowly add 3 grams of sodium bicarbonate to the dilute sulfuric acid solution to neutralize the acid.
- Pour the neutralized solution in the sink with copious amounts of water.

## Data Analysis

---

---

### Determining the volume of the uncalibrated portion of the buret

1. What is the mass of water (g) in the uncalibrated region of your buret?
2. What is the temperature of water in the uncalibrated region of your buret?
3. Using Table 1, what is the volume (in mL/g) of 1 g water at the temperature you reported? Report the volume value closest to your temperature value.
4. Using the volume you determined from Table 1, calculate the volume of water in the uncalibrated region of your buret.

### Determining the vapor pressure of water

1. What was the value of the barometric pressure in mmHg in the laboratory on the day you performed the experiment?
2. For each trial, what is the temperature of the electrolysis solution in °C?
3. For each of your trials, examine Table 2 and determine the corresponding vapor pressure (in mmHg) of water at the temperature at which the electrolysis was performed. Use the vapor pressure value closest to your temperature value.

### Determining the pressure exerted by the column of liquid in the buret

1. For each trial, what is the distance in millimeters between the liquid level in the beaker and the meniscus in the buret at the end of the electrolysis time?
2. For each trial, what is the pressure in mmHg exerted by the column of liquid in your buret? Remember that Hg is 13.6 times as dense as water.

### Determining partial pressure of hydrogen gas

1. For each trial, use the barometric pressure of the laboratory (mm Hg), the vapor pressure of water at electrolysis temperature (mm Hg), and the pressure of the column of liquid in the buret (mm Hg) to determine the partial pressure of H<sub>2</sub> gas in mm Hg.

Hint: Subtract the vapor pressure of water and the column of liquid pressure from the barometric pressure of the laboratory.

2. For each trial, convert the partial pressure of H<sub>2</sub> gas from mmHg to atm.

### Determining moles of hydrogen gas evolved during electrolysis

1. For each trial, what is the volume (in mL) of gas in your buret? Make sure to include the uncalibrated volume of your buret, and keep in mind that volume can be determined by subtracting the direct buret reading from 25.00 mL.
2. For each trial, what is the number of moles of hydrogen gas evolved during electrolysis? Use the pressure and volume of H<sub>2</sub> and the ideal gas law with  $R = 0.0820574 \text{ L atm mol}^{-1} \text{ K}^{-1}$ .

**Determining moles of electrons required to produce evolved moles of hydrogen**

1. For each trial, what is the number of moles of electrons required to produce the evolved moles of hydrogen during the electrolysis? Use the stoichiometric factor relating the moles of hydrogen to the moles of electrons.

Hint: The half reaction at the electron evolving electrode is

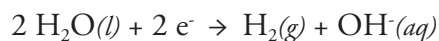
**Determining number of electrons produced during electrolysis**

1. For each trial, what is the total time in seconds of the length of the electrolysis?
2. For each trial, what is the average current in amperes during the electrolysis time?
3. For each trial, what is the number of electrons passing through the external circuit during the electrolysis? Use the current law  $Q = I \times t$ , where  $Q$  is the total charge in Coulombs,  $I$  is the average current in amps and  $t$  is the time in seconds, and the value of the charge of a single electron is,  $e = 1.602176634 \times 10^{-19} \text{ C/e}^-$ .

**Calculating Avogadro's Number,  $N_A$** 

1. To calculate Avogadro's number ( $N_A$ ), divide the number of electrons passing through the circuit by the number of moles of electrons required for the gas evolved during electrolysis. For each trial, what is the result for Avogadro's number?
2. Calculate your average value for Avogadro's number.
3. Calculate the standard deviation for Avogadro's number.
4. Calculate the 90% confidence limit for Avogadro's number.

## Determination of Avogadro's Number



# Chem 2 Series Laboratory

# Procedures and Safety Handbook

Revision Date: February 2024

# Appendix Table of Contents

<b>General Experimental Guidelines</b>	<b>A-5</b>
1. Pre-Laboratory Preparation	
2. Data Collection	
3. Unknowns	
4. Writing A Laboratory Report	
<b>Laboratory Work Grading Policies</b>	<b>A-7</b>
<b>Late Reports &amp; Make-Up Policy</b>	<b>A-8</b>
1. Late Reports	
2. Laboratory Make-Up Policy	
3. Laboratory Make-up Procedure	
4. Plagiarism and Unauthorized Collaboration	
<b>Chemistry Department Safety Policy</b>	<b>A-9</b>
<b>Safety in the Chemistry 2 Laboratories</b>	<b>A-12</b>
<b>Safe Laboratory Practices</b>	<b>A-12</b>
1. Work Under Supervision	
2. Follow Instructions	
3. Safety Equipment	
4. Practice Good Housekeeping	
5. Avoid Chemical Contamination	
<b>Personal Protective Equipment (PPE)</b>	<b>A-14</b>
1. Dress Code	
2. Goggles	
3. Lab Coat	
4. Gloves	
<b>Maps and Emergency Evacuation Procedures</b>	<b>A-16</b>
1. Prior to Exiting	
2. Evacuation Routes/Exiting the Building	
3. Assembly Area	
<b>General Emergency Procedures</b>	<b>A-20</b>
1. Medical Emergency	
2. Major Incident	
3. Fire Alarm	
<b>Dispensary Procedures</b>	<b>A-21</b>
<b>Safety Data Sheet</b>	<b>A-22</b>
<b>Hazardous Chemicals</b>	<b>A-31</b>
Hazardous Chemicals	<b>A-31</b>
Hazardous Waste	<b>A-32</b>

<b>Statistical Treatment of Data</b>	<b>A-34</b>
1. Average and Standard Deviation	
2. Confidence Limits	
3. Relative Deviation	
4. Analysis of Poor Data: Q-test	
<b>An Introduction to Excel</b>	<b>A-38</b>
Excel Basics	A-39
Calculations in Excel	A-43
Graphing in Excel	A-46
<b>Common Laboratory Procedures</b>	<b>A-50</b>
Handling Solids	A-50
1. General Guidelines for Handling Solids	
2. Quantitative Transfer	
3. Using the Desiccator	
Handling Liquids	A-52
1. Drawing Solutions from a Reagent Bottle	
2. Estimating Volume with a Dispo Pipet	
3. Transferring Liquid	
4. Capping a Flask with Parafilm	
5. Measuring Liquid Volumes	
Common Glassware in the Laboratory	A-55
1. Care and Maintenance of Laboratory Glassware	
2. Beakers	
3. Erlenmeyer Flasks	
4. Graduated Cylinder	
5. Volumetric Flasks	
6. Burets	
7. Volumetric Pipet	
Using the Balance	A-61
1. On/Off Switching	
2. Simple Weighing	
3. Taring	
4. Weighing by Difference	
Using the Centrifuge	A-63
1. Procedure	
2. Safety Precautions	
Using the Hot Plate	A-64
1. Features	
2. Safety Precautions	
Heating with a Bunsen Burner	A-66
Setting up a Titration Apparatus	A-67
Filtration	A-68

## pH Meter Operating Instructions

**A-69**

1. Preparing the pH meter
2. Calibrating the pH meter
3. Measure the pH of sample

## Fume Hood Use and Safety

**A-72**

1. Features of the Fume Hood
2. Before using the fume hood
3. Guidelines for working with the fume hood
4. Using the fume hoods in the Chemistry 2 Laboratories
5. Fume Hood Emissions

## Locker Inventory

**A-75**

Start of Quarter Check-In

**A-75**

End of Quarter Check-Out

**A-76**

# General Experimental Guidelines

---

The laboratory is a critical component of your study of chemistry. Therefore, a student must complete **all of the assigned laboratory work**, including all on- & off-line post-laboratory exercises, in order to pass this course.

## 1. Pre-Laboratory Preparation

- You are required to prepare for each experiment by doing the following:
- Carefully read the experiment and write a Title, Purpose, Procedure (brief outline), and Data (outline) section before arriving at the laboratory. A detailed description of each section is described below under, “Writing a Laboratory Report”.
- You must complete the on-line pre-laboratory presentation and must pass the pre-laboratory quiz.

**If you have not completed the pre-lab preparation** at the beginning of the laboratory period, you will be deemed unsafe to perform the experiment and must leave the laboratory until the pre-laboratory write up is complete and your TA is convinced that you are prepared to begin the experiment.

## 2. Data Collection

All data must be recorded *in blue or black ink* directly into your laboratory notebook. At the completion of the experiment, you must turn in a copy of your data sheet to your TA *before* you leave the laboratory.

## 3. Unknowns

Students will obtain all unknowns from the TA. Students must be explicit in their request for an unknown; that is, they must know the name of the experiment and unknown. If a student needs more unknown, they should notify the TA who will then write a note of explanation that the student can take to the dispensary. The note should contain the student's name, the student's locker number, the laboratory section number, the TA's name, the experiment name, and the name of the unknown.

## 4. Writing A Laboratory Report

Below is the suggested format that your report should follow. Portions of the report should be written in your laboratory notebook and others will be submitted on-line as part of the post laboratory exercises. Post laboratory exercises are due one week after the completion of the laboratory.

## General Experimental Guidelines

Below is a general outline of a common format that is often used in science laboratory courses. Discuss this format with your TA during the first laboratory period so that you clearly understand what will be expected. All reports must be written in **non-erasable blue or black ink**. A date should be indicated on each report. Your notebook should be organized and written in such a manner that another chemist could read it and repeat the experiment in precisely the same way.

- **Title:** The report should have a title that concisely describes the experiment.
- **Purpose:** A brief and concise statement that describes the goals of the experiment and the methods employed. Any pertinent chemical reactions are generally indicated. State the purpose of the experiment in the form of a complete sentence. Do not start with the word "To."
- **Procedure:** A brief and concise outline of each step of the experiment should be included. If you are using a published procedure, you should also cite the literature or laboratory manual. A drawing of the apparatus may also be included.
- **Data and Observations:** Report all measurements and observations that are pertinent to the experiment. Be sure to note any problems or unexpected occurrences. It is important that this section be as neat and as organized as possible. The use of tables will often help in this regard. All data must be recorded in **blue or black ink** directly into the notebook at the time it is collected. A severe penalty will be imposed for pencil or transcribed data entries. Do not erase mistakes. Simply draw a line through the error and record the correction. Your notebook is subject to examination at any time.

The following sections are to be submitted on-line as part of the post-laboratory exercise. You should complete the post-lab report as soon as possible after the completion of the experiment as this is much more efficient than waiting until the night before the experiment is due.

- **Calculations:** This section generally includes any complicated calculations that are involved in the experiment. Again, it is important to use foresight when organizing this section.
- **Questions:** All assigned questions are answered in this section.
- **Results & Conclusions:** Report the outcome of the experiment.

# Laboratory Work Grading Policies

---

**1. Pre-lab lab notebook preparation incomplete:**

- 30% of post-lab score deduction for first offense.
- 70% of post lab score deduction for subsequent offenses.
- No extra time or make-up

**2. Online Pre-lab quiz failed or incomplete 1 hour before lab begins:**

- 0/2 points for the pre-lab quiz

**3. Late reports**

- 5-point deduction for every calendar day the report is late

# Late Reports & Make-Up Policy

---

## 1. Late Reports

Laboratory reports are due at the beginning of the period after the one allocated for the completion of the experiment. The last report each quarter is due at the time indicated by the TA. Late reports will be met with a 5-point deduction for every calendar day the report is late.

## 2. Laboratory Make-Up Policy

You must attend the laboratory class for the section in which you are enrolled. **If you miss a laboratory class with an excused absence, it must be made up before the end of the following week of laboratory. No laboratory make-ups will be offered after one week from the scheduled date of the lab.** If you miss the last lab of the quarter, it must be made up **immediately**. No make ups for unexcused absences.

**Excused absences include an extended illness, accidents, or family emergencies. Vacation, cruises, and IM sports are not considered excused.** Bring documented proof of your excused absence to your TA or head TA immediately upon return. If you cannot present this documentation or have an unexcused absence, you may receive a failing grade in the course.

You are required to complete all labs in order to pass the course and it is your responsibility to find an open laboratory in the same course promptly. Failure to make up a lab may result in a **failing grade** for the course.

## 3. Laboratory Make-up Procedure

If you miss a lab, you must make it up by attending another scheduled laboratory section. It is your responsibility to find an open laboratory in the same course. Consult the Class Schedule and Room Directory for a listing of rooms and times. Go to the selected laboratory section and ask the teaching assistant if you may be admitted to make up a lab. You must be on time for the start of the lab period. If there is room in the class, the teaching assistant will allow you in the lab, unlock your locker, and allow you to do the lab. Make sure to record the **teaching assistant's name, date, time and room number** where you made up the laboratory. Have the TA collect your data sheet and he or she will give it to your regularly assigned teaching assistant. **No laboratory report will be accepted without a valid copy of the data sheet.**

## 4. Plagiarism and Unauthorized Collaboration

Some of your experiments will be done with lab partners. You are encouraged to discuss your data and its analysis and interpretation with your lab partner, other students and the TAs. However, the actual data analyses and the written reports **must** be done entirely independently of your lab partner or other students. Make sure that you avoid unauthorized collaboration and plagiarism. All suspected violations of the Code of Academic Conduct will be referred to Student Judicial Affairs.



# Chemistry Department Safety Policy

---

## U.C. Davis Department of Chemistry Chem. 2 Series

### Standard Operating Procedures

#### **SAFETY RULES FOR TEACHING LABORATORIES**

The following rules are designed for your safety and it is your responsibility to follow these rules. The Laboratory Instructor (LI = TA, Laboratory Supervisor, and/or Course Instructor) must enforce these rules, approved by Department of Chemistry Staff, Faculty, and Department Safety Manager. The LI must also enforce all experiment-specific safety rules pertaining to laboratory work, including rules not explicitly mentioned here. Violation of these rules will result in expulsion from the laboratory.

1. No one is permitted in the lab without the supervision of an LI. No lab work will be done without supervision. Perform only authorized experiments, and only in the manner instructed. Do *not* alter experimental procedures, except as instructed.
2. Specific permission from your LI is required before working in any lab section other than the one assigned to you. Only lab rooms where the same lab course is operating may be used for this purpose.
3. If you have a special health condition (asthma, pregnancy, etc.) or any personal health concerns, consult your medical professional before taking chemistry lab. If you require accommodations such as wheelchair access, service animals, or other, consult with the Department Safety Manager.
4. Students must come to the lab with appropriate lab attire and personal protective equipment (PPE). Without either, you will not be allowed to enter or make-up the lab, and your course grade will be affected. If you cannot wear the required PPE or lab attire, you must meet with the Department Safety Manager before you are allowed to enter the lab.
5. The appropriate PPE requirements include the following:
  - a. Properly-fitted white 100% cotton lab coats. Lab coat sleeves must cover your wrist and should cover your thighs when seated. Disposable, flimsy, short, or dyed lab coats are *not* allowed.
  - b. Approved safety goggles must be worn at all times. Safety goggles may not be modified in any manner. Visorgog, safety glasses, swimming goggles, or similar eyewear are not acceptable in the lab.
6. Lab attire must be made of durable material to protect from incidental chemical splash. Appropriate lab attire includes:
  - a. Clothing that completely covers the legs - including the skin between the top of the shoe and the bottom of the pant leg - must be worn at all times in the lab. Leg coverings must extend to the shoes. Socks must be long enough to cover the ankles while seated. Tights,

## Chemistry Department Safety Policy

leggings, joggers, yoga pants, pants with holes, pants with slits, etc. are not suitable leg covering regardless of material. No-show socks are *not* allowed.

- b. Closed-toe, closed-heel shoes that completely cover the entire foot (including the top of the foot) must be worn at all times. Crocs, jellies, boat shoes, low-heel slippers, slides, slip-ons, etc. are not allowed. Socks are not suitable replacements for shoes or leg coverings.
  - c. Because inadequate protection often leads to injury, it is recommended to ensure all skin below the neck is covered.
  - d. Avoid wearing expensive clothing or jewelry to the lab as it may get damaged.
7. All students must adhere to safe lab practices, including the following:
- a. Horseplay and carelessness are not permitted and are cause for expulsion from the lab.
  - b. You must be fully attentive and aware of your surroundings, and remove distractions as directed by your LI.
  - c. Skateboards, rollerblades, motorized scooters, bicycles, and other transportation devices must be stored outside of the lab. Personal electronics are only permitted when needed for the lab. Cell phones or other personal electronic media can be damaged or contaminated in the lab. Use of such devices is at the student's own risk.
  - d. Tie back long hair, loose hair, or hair that blocks your vision. Pin back loose headwear.
  - e. Absolutely *no* food or drinks are to be stored or consumed in the lab. Contact lenses and cosmetics (hand lotion, lip balm, etc.) are not to be applied, and medications are not to be consumed while in the lab.
  - f. Lab doors must remain closed except when individuals are actively entering or exiting the lab.
  - g. The student must have at least *one ungloved hand* when outside the lab. Gloves are presumed to be contaminated and must not come into contact with anything outside the lab except chemical containers. Only use the ungloved hand to open doors, hold on to stair rails, or push elevator buttons.
8. Follow all instructions on safe chemical handling and safe equipment handling, including the following:
- a. Mouth suction must never be used to fill pipets.
  - b. All activities in which toxic gases or vapors are used or produced must be carried out in the fume hood.
  - c. Containers of chemicals may not be taken out of the lab except to the dispensary for refill/replacement or to exchange full waste jugs for empty ones. All containers must be closed with the appropriate cap before you take them into the hallway to the dispensary. Always use a bottle carrier when transporting chemicals and waste.
  - d. Put hazardous waste into appropriate waste container(s) provided in your lab. Do not overfill waste containers.

- e. Keep your working area clean – immediately clean up *all* spills or broken glassware. Dispose sharps in the appropriate container. Do not dispose pipette tips in regular trash. Clean off your lab workbench before leaving the lab.
9. Learn how to respond to emergencies and report incidents promptly to the LI:
- a. Learn the location and how to operate the nearest eyewash fountain, safety shower, fire extinguisher, and fire alarm box. Basic first aid for any chemical splash is to wash the affected area for at least 15 minutes and seek medical attention. Use the emergency shower if appropriate, removing contaminated clothing for thorough washing. If the safety shower or eyewash is activated, the exposed person should be accompanied to the Student Health Center for further evaluation.
  - b. All incidents, near misses, injuries, explosions, or fires must be reported at once to the LI. In case of serious injury or fire (even if the fire is out), the LI must call 911. The student must always be accompanied to the Student Health Center.

Students must sign the Safety Acknowledgement sheet before working in the lab. If you have any questions, please ask your LI before starting any lab work.

# Safety in the Chemistry 2 Laboratories

---

Students are an integral part of accident and injury prevention effort. The laboratory safety rules require the students to follow Safe Laboratory Practices and wear the proper **Personal Protective Equipment (PPE)**.

## Safe Laboratory Practices

Using safe laboratory practices prevents most accidents and injuries from occurring. Remember that you are sharing the same work area with 23 other students. Any unsafe practices on the part of your fellow students may end up injuring you or others. Courteously correct unsafe lab practices you may encounter or report them to your TA. Laboratory safety is a communal effort.

### 1. Work Under Supervision

Your TA must be present to supervise all experiments. If your TA is incapacitated, contact dispensary staff immediately.

Report all accidents and injuries to your TA, no matter how small.

### 2. Follow Instructions

The Chemistry 2 laboratory is designed to minimize the hazard exposure to students. Failure to follow the lab manual instructions may result in accidents and injuries to you and others around you.

Always follow the manual unless directly instructed by your Laboratory Instructor or the teaching lab staff.

Follow all instructions posted in the laboratory.

### 3. Safety Equipment

There are many safety types of equipment in the Chemistry 2 laboratory. Learn where they are and how to operate them.

- **Exits**

The ability to remove yourself from a dangerous situation is one of the most important safety skills you have.

**Keep the exits clear.** Do not block exits with backpacks, skateboards, bicycles, etc.

**Keep the doors closed.** Do not prop the door open.

- **Fire Extinguisher**

Learn the location of the fire extinguisher. It is usually placed next to an exit.

- **Eyewash**

Learn the location of the eyewash. For chemical spills in your eyes, use the Eyewash fountain. Hold your eyelids open and wash affected area water for 15 minutes with water. Seek medical attention.

- **Drenching Hose and Safety Shower**

Learn the location of the drench hose and safety shower.

For large spills on your body, use the **safety shower**.

- Remove contaminated clothing and wash affected area with water. Seek medical attention immediately.
- When the safety shower is used, all other students must evacuate the room.

The TA **must** dial 911 and inform the Fire Department that the safety shower is used.

For small chemical spills on your arms and hands, use the **drench hose**.

- Wash affected area water for 15 minutes with water and contact your TA. You may also use the tap water faucet if it is adequate for washing the affected area. It is advised that you seek medical attention for even minor burns.

- **Fire Alarm Box**

The fire alarm boxes in the Science Lab building are located in the hallway.

#### 4. Practice Good Housekeeping

Keep work area organized. Don't put glassware on edges where they may fall off.

Cap all bottles and close all drawers immediately.

Clean up all spills and broken glassware immediately.

#### 5. Avoid Chemical Contamination

Do not bring food and drinks into labs.

Do not consume or use food, beverage, medicine, chewing gum, or tobacco, apply makeup or contact lenses in the laboratory.

Take off one glove when leaving the laboratory. Do not touch anything outside the laboratory with your laboratory gloves.

Wash your hands thoroughly before leaving the lab.

## Personal Protective Equipment (PPE)

Students must come to the laboratory section with the appropriate personal protective equipment. The PPE is the last line of defense against chemical hazards in the laboratory. Failure to don the appropriate PPE will result in your removal from the laboratory. Many students may find it helpful to keep a bag dedicated to chemistry lab courses with the proper clothing and PPE and change into them before class.

### 1. Dress Code

Clothing worn in the laboratory should be able to protect you from small splashes and spills of liquids. For the Chemistry 2 laboratories, students are required to have long sleeves, long pants, and shoes that cover the entirety of the foot.

- **Long sleeve shirt and long pants:**

You must wear clothing that covers your arms, legs, wrists and ankles to protect you from small spills. Tights or leggings do not qualify. Do not wear clothing with holes in them as they will not protect you from spills.

- **Shoes that cover the entirety of the foot and socks to cover the ankles:**

You must wear closed-toe, closed-heeled shoes that completely cover your foot. Do not wear sandals, slippers, or shoes that expose the back of your foot. Broken glassware and spilled chemicals are more likely to land on your foot than anywhere else. Also remember to wear socks to cover your ankles. The area between your shoes and pants should not be exposed when you are seated.

A good rule of thumb to keep in mind is: **No skin exposure from the neck down to the feet in the laboratory.**

### 2. Goggles

Lab goggles are designed to protect your eyes. Injury to the eyes is often irreversible and may severely impact your future. Always wear approved goggles when working in the laboratory.

- **Approved Goggles**

ANSI Z87.1-compliant chemical splash goggles with indirect venting is required for the Chemistry 2 course. Approved lab goggles may be purchased at the MU Bookstore, the Silo Bookstore or the ARC Pro Shop in the Activity and Recreation Center.

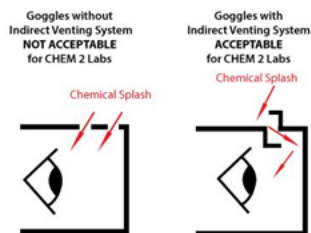

- **Goggles Rules**

Modified goggles will not be allowed in the lab. Do not modify the goggles by adjusting or removing the indirect venting system.

Goggles strap must be adjusted to fit properly at all times.

**Never** take off your goggles in the laboratory. If you need to adjust your goggles or if they fog up, leave the laboratory and return when your goggles issues are resolved.

### 3. Lab Coat

You must provide your own lab coat for all chemistry lab courses. Only wear lab coats during the laboratory. Take off your lab coat immediately after lab. Do not wear lab coat outside the laboratory.

Your lab coat must be made of 100% cotton. Disposable, synthetic lab coats are not acceptable.

Your lab coat must be properly fitted so that it protects your arms and body. The sleeves of your lab coat must fully extend to the wrists. Do not wear a lab coat that that's too small or too big for you.

Keep your lab coat buttoned at all times.

### 4. Gloves

You will be provided with disposable nitrile gloves in lab for you protection. Do not bring your own gloves.

Wear gloves when handling hazardous chemicals or contacting potentially contaminated surfaces.

Never re-use disposable gloves. **Remove and replace contaminated nitrile gloves immediately.**

- **Allergy**

If you are allergic to nitrile gloves, contact your TA and the laboratory staff. You will be provided with hypoallergenic lab gloves.

- **Fit**

Make sure you wear the correct sized gloves. Gloves that are too large for your hand greatly increase the likelihood of accidents.

# Maps and Emergency Evacuation Procedures

---

---

## 1. Prior to Exiting

After being notified to evacuate, cease all work activities and evacuate immediately.

Stop all reactions and turn off all sources of ignition.

Close, but do not lock, the doors. Take your purse, briefcase, backpack and keys with you if possible. Remember that you may not be allowed back into the building for an extended time.

## 2. Evacuation Routes/Exiting the Building

During an emergency evacuation, use the nearest door or stairway if available to exit the building. Do not use elevators for fire/earthquake evacuations.

Be aware of at least two exit routes in the event one is compromised.

## 3. Assembly Area

After exiting the building, all occupants should follow the evacuation route to the pre-arranged assembly area.

**DO NOT** return to the building until notified by emergency personnel. Supervisors must take roll to ensure all occupants have safely evacuated the building.



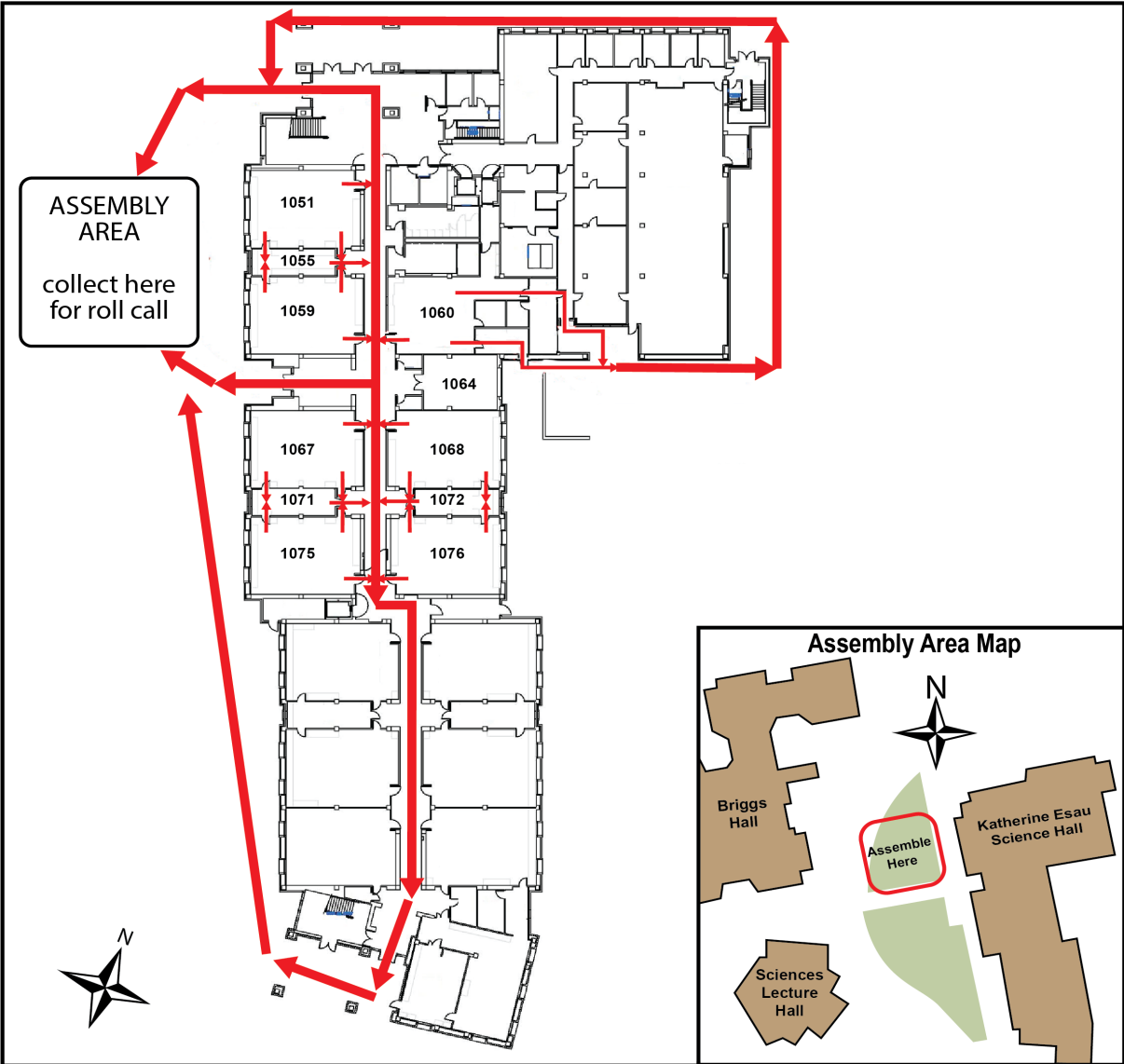

Figure 1. Evacuation routes for the 1st floor Esau Hall rooms.

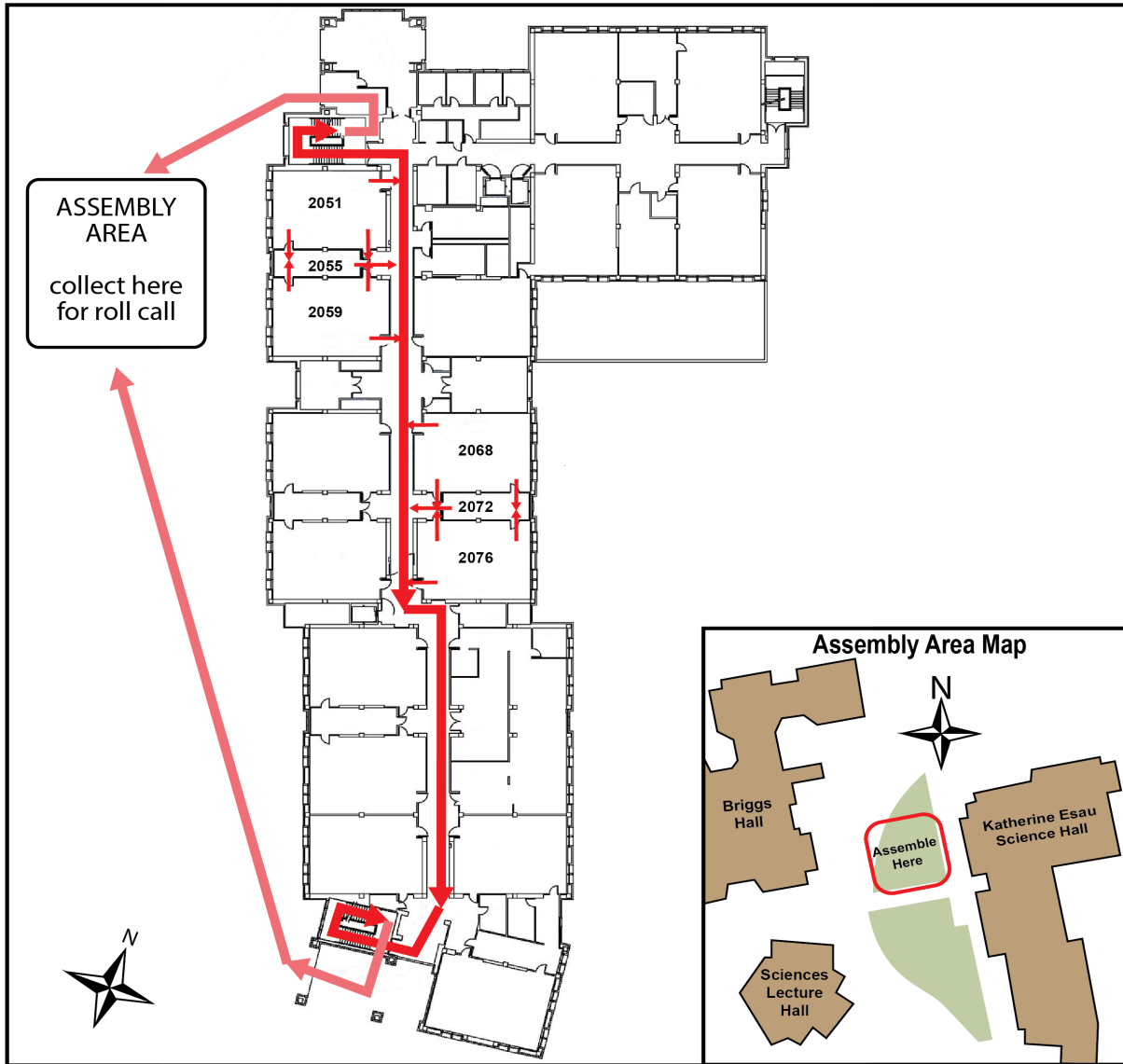

Figure 2. Evacuation routes for the 2nd floor Esau Hall rooms.



Figure 3. The assembly area for Chemistry 2 students and personnel.

# General Emergency Procedures

---

The following are some general instructions for actions to take in case of an emergency:

## 1. Medical Emergency

- 1) Remain calm.
- 2) Initiate lifesaving measures if required.
- 3) TA will call for the dispensary supervisor and/or for Emergency Response—CALL 911.
- 4) Do not move injured persons unless it is necessary to prevent further harm.
- 5) Keep injured person warm.

## 2. Major Incident

- 1) Alert TA to injured or contaminates persons.
- 2) Alert people to evacuate the area.
- 3) TA will call for the dispensary supervisor and/or Emergency Response—CALL 911.

**Fire**.....911

**Chemical, radiation, biological spill**.....911

**(Evenings and Weekends)**.....911

- 4) Close doors to affected areas.
- 5) Have person knowledgeable of incident inform the TA.

## 3. Fire Alarm

- 1) When fire alarm sounds, evacuate the room and follow evacuation plan to the Assembly Area. The Assembly Area is on the south side of the large tree, which is on the west side of the Esau Hall.
- 2) TAs must take roll to ensure all students are accounted for.
- 3) If the building is cleared, you will return to continue your lab.

# Dispensary Procedures

---

## 1. Dispensary Location and Policies

The CHE2 dispensary is located on the first floor of the Esau Hall in **Room 1060**. Go to the **dispensary roll-up window (1060E)** for service.

You must wear the proper PPE to the dispensary. This includes your **lab coat and goggles**. Remember that you should have at least **one ungloved hand** while outside your laboratory.

## 2. Dispensing Policies

### a.) Policies at the Beginning of the Quarter

**Goggles and Lab Coat:** You are required to provide your own goggles and lab coats.

**Locker Supplies:** It is required that you do a locker inventory during the first week of labs. Make sure that you have everything on your locker list by the end of the second week of instruction.

### b.) Policies During the Quarter

**Locker Supplies:** If a locker item is broken after the initial two-week period, go to the dispensary to request a replacement. You must know the exact name and specification of the item to be replaced.

**Refilling of Chemical and Supply Containers:** When replacing or refilling general laboratory chemicals or supplies, be sure to bring the empty containers to the dispensary. Be sure all containers are closed with the correct cap and placed in the correct bottle carrier.

To avoid chemical contamination and equipment breakage, please refrain from bringing personal bags and backpacks to dispensary window when seeking replacement chemical containers or lab equipment.

**Waste Containers:** Call the dispensary for replacements when waste containers are full.

### c.) Policies at the End of the Quarter

**Surplus Stores:** Any item you may have in surplus should be placed in the area set aside for surplus items in the laboratory (a box at the back of the lab).

**Filling Locker Requirements:** If your locker is short of any items when you are checking your locker equipment against your locker list, obtain the missing items from the surplus items in the laboratory. If the missing item is not in the surplus area, obtain it from the dispensary.

**Preparing Your Locker for Check-Out:** Clean and quickly dry all equipment. Replace all broken or missing items by checking them out from the dispensary. Return all extra equipment to the extra glassware box in the lab. Have your TA check the contents of the locker and if everything is present and clean then they will lock the drawer.

# Safety Data Sheet

---

The Safety Data Sheet (SDS) is a document that provides information to enable users of a substance or mixture to take the necessary measures relating to protection of health and safety at the workplace, and the protection of the environment. A Safety Data Sheet has the following sections:

1. Identification;
2. Hazard identification;
3. Composition/information on ingredients;
4. First-aid measures;
5. Fire-fighting measures;
6. Accidental release measures;
7. Handling and storage;
8. Exposure controls/personal protection;
9. Physical and chemical properties;
10. Stability and reactivity;
11. Toxicological information;
12. Ecological information;
13. Disposal considerations;
14. Transport information;
15. Regulatory information;
16. Other information.

A list of SDS resources may be found at: <http://ehs.ucop.edu/sds>

The following pages show a sample SDS for the **6 M Hydrochloric Acid** commonly used in the CHE2 laboratory courses.



# Fisher Scientific

Part of Thermo Fisher Scientific

## SAFETY DATA SHEET

Creation Date 24-Aug-2009

Revision Date 24-Feb-2014

Revision Number 1

### 1. Identification

**Product Name** Hydrochloric Acid Solution, 6N (Certified)  
**Cat No. :** SA56-1; SA56-4; SA56-200; SA56-500  
**Synonyms** Chlorohydric acid; Hydrogen chloride solution.; Muriatic acid  
**Recommended Use** Laboratory chemicals.  
**Uses advised against** No Information available  
**Details of the supplier of the safety data sheet**

**Company**

Fisher Scientific  
One Reagent Lane  
Fair Lawn, NJ 07410  
Tel: (201) 796-7100

**Emergency Telephone Number**

CHEMTREC®, Inside the USA: 800-424-9300  
CHEMTREC®, Outside the USA: 001-703-527-3887

### 2. Hazard(s) identification

**Classification**

This chemical is considered hazardous by the 2012 OSHA Hazard Communication Standard (29 CFR 1910.1200)

Corrosive to metals	Category 1
Skin Corrosion/Irritation	Category 1 B
Serious Eye Damage/Eye Irritation	Category 1
Specific target organ toxicity (single exposure)	Category 3
Target Organs - Respiratory system.	

**Label Elements**

**Signal Word**

Danger

**Hazard Statements**

May be corrosive to metals  
Causes severe skin burns and eye damage  
May cause respiratory irritation



**Precautionary Statements****Prevention**

Do not breathe dust/fume/gas/mist/vapors/spray  
 Wash face, hands and any exposed skin thoroughly after handling  
 Wear protective gloves/protective clothing/eye protection/face protection  
 Use only outdoors or in a well-ventilated area  
 Keep only in original container

**Response**

Immediately call a POISON CENTER or doctor/physician

**Inhalation**

IF INHALED: Remove victim to fresh air and keep at rest in a position comfortable for breathing

**Skin**

IF ON SKIN (or hair): Take off immediately all contaminated clothing. Rinse skin with water/shower  
 Wash contaminated clothing before reuse

**Eyes**

IF IN EYES: Rinse cautiously with water for several minutes. Remove contact lenses, if present and easy to do. Continue rinsing

**Ingestion**

IF SWALLOWED: Rinse mouth. DO NOT induce vomiting

**Spills**

Absorb spillage to prevent material damage

**Storage**

Store locked up  
 Store in a well-ventilated place. Keep container tightly closed  
 Store in corrosive resistant polypropylene container with a resistant inliner  
 Store in a dry place

**Disposal**

Dispose of contents/container to an approved waste disposal plant

**Hazards not otherwise classified (HNOC)**

None identified

### 3. Composition / information on ingredients

Component	CAS-No	Weight %
Water	7732-18-5	>78
Hydrochloric acid	7647-01-0	22

### 4. First-aid measures

**General Advice**

If symptoms persist, call a physician.

**Eye Contact**

Rinse immediately with plenty of water, also under the eyelids, for at least 15 minutes. Immediate medical attention is required.

**Skin Contact**

Wash off immediately with plenty of water for at least 15 minutes. Immediate medical attention is required.

**Inhalation**

Move to fresh air. If breathing is difficult, give oxygen. Do not use mouth-to-mouth method if victim ingested or inhaled the substance; give artificial respiration with the aid of a pocket mask equipped with a one-way valve or other proper respiratory medical device. Immediate



medical attention is required.

**Ingestion** Do not induce vomiting. Call a physician or Poison Control Center immediately.

**Most important symptoms/effects** Causes burns by all exposure routes. Product is a corrosive material. Use of gastric lavage or emesis is contraindicated. Possible perforation of stomach or esophagus should be investigated: Ingestion causes severe swelling, severe damage to the delicate tissue and danger of perforation

**Notes to Physician** Treat symptomatically

## 5. Fire-fighting measures

**Suitable Extinguishing Media** Substance is nonflammable; use agent most appropriate to extinguish surrounding fire.

**Unsuitable Extinguishing Media** No information available

**Flash Point** No information available  
**Method -** No information available

**Autoignition Temperature** No information available

**Explosion Limits**

**Upper** No data available

**Lower** No data available

**Sensitivity to Mechanical Impact** No information available

**Sensitivity to Static Discharge** No information available

### Specific Hazards Arising from the Chemical

Non-combustible, substance itself does not burn but may decompose upon heating to produce corrosive and/or toxic fumes.

### Hazardous Combustion Products

Hydrogen chloride gas Carbon monoxide (CO) Carbon dioxide (CO<sub>2</sub>) Hydrogen

### Protective Equipment and Precautions for Firefighters

As in any fire, wear self-contained breathing apparatus pressure-demand, MSHA/NIOSH (approved or equivalent) and full protective gear.

### NFPA

**Health**  
3

**Flammability**  
0

**Instability**  
1

**Physical hazards**  
N/A

## 6. Accidental release measures

**Personal Precautions** Use personal protective equipment. Ensure adequate ventilation. Evacuate personnel to safe areas.

**Environmental Precautions** Should not be released into the environment. See Section 12 for additional ecological information.

**Methods for Containment and Clean Up** Soak up with inert absorbent material. Keep in suitable, closed containers for disposal.

## 7. Handling and storage

**Handling** Use only under a chemical fume hood. Ensure adequate ventilation. Wear personal protective equipment. Do not get in eyes, on skin, or on clothing. Do not breathe vapors or spray mist. Do not ingest.

**Storage** Keep containers tightly closed in a dry, cool and well-ventilated place.

## 8. Exposure controls / personal protection

### Exposure Guidelines

Component	ACGIH TLV	OSHA PEL	NIOSH IDLH
Hydrochloric acid	Ceiling: 2 ppm	Ceiling: 5 ppm Ceiling: 7 mg/m <sup>3</sup> (Vacated) Ceiling: 5 ppm (Vacated) Ceiling: 7 mg/m <sup>3</sup>	IDLH: 50 ppm Ceiling: 5 ppm Ceiling: 7 mg/m <sup>3</sup>

Component	Quebec	Mexico OEL (TWA)	Ontario TWAEV
Hydrochloric acid	Ceiling: 5 ppm Ceiling: 7.5 mg/m <sup>3</sup>	Ceiling: 5 ppm Ceiling: 7 mg/m <sup>3</sup>	CEV: 2 ppm

**Legend**

**ACGIH** - American Conference of Governmental Industrial Hygienists

**OSHA** - Occupational Safety and Health Administration

**NIOSH IDLH**: The National Institute for Occupational Safety and Health Immediately Dangerous to Life or Health

**Engineering Measures**

Use only under a chemical fume hood. Ensure that eyewash stations and safety showers are close to the workstation location.

**Personal Protective Equipment****Eye/face Protection**

Wear appropriate protective eyeglasses or chemical safety goggles as described by OSHA's eye and face protection regulations in 29 CFR 1910.133 or European Standard EN166.

**Skin and body protection**

Wear appropriate protective gloves and clothing to prevent skin exposure.

**Respiratory Protection**

Follow the OSHA respirator regulations found in 29 CFR 1910.134 or European Standard EN 149. Use a NIOSH/MSHA or European Standard EN 149 approved respirator if exposure limits are exceeded or if irritation or other symptoms are experienced.

**Hygiene Measures**

Handle in accordance with good industrial hygiene and safety practice.

## 9. Physical and chemical properties

<b>Physical State</b>	Liquid
<b>Appearance</b>	Clear
<b>Odor</b>	pungent
<b>Odor Threshold</b>	No information available
<b>pH</b>	1
<b>Melting Point/Range</b>	-74 °C / -101.2 °F
<b>Boiling Point/Range</b>	81.5 - 110 °C / 178.7 - 230 °F @ 760 mmHg
<b>Flash Point</b>	No information available
<b>Evaporation Rate</b>	> 1.00 (Butyl Acetate = 1.0)
<b>Flammability (solid,gas)</b>	Not applicable
<b>Flammability or explosive limits</b>	
<b>Upper</b>	No data available
<b>Lower</b>	No data available
<b>Vapor Pressure</b>	5.7 mmHg @ 0 °C
<b>Vapor Density</b>	1.26
<b>Specific Gravity</b>	1.0 - 1.2
<b>Solubility</b>	Miscible with water
<b>Partition coefficient; n-octanol/water</b>	No data available
<b>Autoignition Temperature</b>	No information available
<b>Decomposition Temperature</b>	No information available
<b>Viscosity</b>	No information available

## 10. Stability and reactivity

<b>Reactive Hazard</b>	None known, based on information available
<b>Stability</b>	Stable under normal conditions. Water reactive.
<b>Conditions to Avoid</b>	Incompatible products. Excess heat. Exposure to moist air or water.
<b>Incompatible Materials</b>	Metals, Oxidizing agents, Reducing agents, Acids, Bases, Aldehydes
<b>Hazardous Decomposition Products</b>	Hydrogen chloride gas, Carbon monoxide (CO), Carbon dioxide (CO <sub>2</sub> ), Hydrogen
<b>Hazardous Polymerization</b>	Hazardous polymerization does not occur.
<b>Hazardous Reactions</b>	May react with metals and lead to the formation of flammable hydrogen gas. Corrosive to metals.

## 11. Toxicological information

### Acute Toxicity

#### Product Information

##### Oral LD50

Based on ATE data, the classification criteria are not met. ATE > 2000 mg/kg.

##### Dermal LD50

Based on ATE data, the classification criteria are not met. ATE > 2000 mg/kg.

##### Vapor LC50

Based on ATE data, the classification criteria are not met. ATE > 20 mg/l.

#### Component Information

Component	LD50 Oral	LD50 Dermal	LC50 Inhalation
Water	-	Not listed	Not listed
Hydrochloric acid	LD50 238 - 277 mg/kg ( Rat )	LD50 > 5010 mg/kg ( Rabbit )	LC50 = 1.68 mg/L ( Rat ) 1 h

**Toxicologically Synergistic Products** No information available

### Delayed and immediate effects as well as chronic effects from short and long-term exposure

**Irritation** Causes burns by all exposure routes

**Sensitization** No information available

**Carcinogenicity** The table below indicates whether each agency has listed any ingredient as a carcinogen.

Component	CAS-No	IARC	NTP	ACGIH	OSHA	Mexico
Water	7732-18-5	Not listed	Not listed	Not listed	Not listed	Not listed
Hydrochloric acid	7647-01-0	Not listed	Not listed	Not listed	Not listed	Not listed

**Mutagenic Effects** No information available

**Reproductive Effects** No information available.

**Developmental Effects** No information available.

**Teratogenicity** No information available.

**STOT - single exposure** Respiratory system

**STOT - repeated exposure** None known

**Aspiration hazard** No information available

**Symptoms / effects, both acute and delayed** Product is a corrosive material. Use of gastric lavage or emesis is contraindicated. Possible perforation of stomach or esophagus should be investigated: Ingestion causes severe swelling, severe damage to the delicate tissue and danger of perforation

**Endocrine Disruptor Information** No information available

**Other Adverse Effects** The toxicological properties have not been fully investigated.

## 12. Ecological information

### Ecotoxicity

Do not empty into drains.

Component	Freshwater Algae	Freshwater Fish	Microtox	Water Flea
Hydrochloric acid	-	282 mg/L LC50 96 h	-	-

**Persistence and Degradability** Persistence is unlikely based on information available.

**Bioaccumulation/ Accumulation** No information available.

**Mobility** No information available.

## 13. Disposal considerations

**Waste Disposal Methods** Chemical waste generators must determine whether a discarded chemical is classified as a hazardous waste. Chemical waste generators must also consult local, regional, and national hazardous waste regulations to ensure complete and accurate classification.

## 14. Transport information

### DOT

UN-No UN1789  
 Proper Shipping Name HYDROCHLORIC ACID SOLUTION  
 Hazard Class 8  
 Packing Group II

### TDG

UN-No UN1789  
 Proper Shipping Name HYDROCHLORIC ACID SOLUTION  
 Hazard Class 8  
 Packing Group II

### IATA

UN-No UN1789  
 Proper Shipping Name HYDROCHLORIC ACID SOLUTION  
 Hazard Class 8  
 Packing Group II

### IMDG/IMO

UN-No UN1789  
 Proper Shipping Name HYDROCHLORIC ACID, SOLUTION  
 Hazard Class 8  
 Packing Group II

## 15. Regulatory information

### International Inventories

Component	TSCA	DSL	NDSL	EINECS	ELINCS	NLP	PICCS	ENCS	AICS	IECSC	KECL
Water	X	X	-	231-791-2	-		X	-	X	X	X
Hydrochloric acid	X	X	-	231-595-7	-		X	X	X	X	X

#### Legend:

X - Listed

E - Indicates a substance that is the subject of a Section 5(e) Consent order under TSCA.

F - Indicates a substance that is the subject of a Section 5(f) Rule under TSCA.

N - Indicates a polymeric substance containing no free-radical initiator in its inventory name but is considered to cover the designated polymer made with any free-radical initiator regardless of the amount used.

P - Indicates a commenced PMN substance

R - Indicates a substance that is the subject of a Section 6 risk management rule under TSCA.

S - Indicates a substance that is identified in a proposed or final Significant New Use Rule

T - Indicates a substance that is the subject of a Section 4 test rule under TSCA.

XU - Indicates a substance exempt from reporting under the Inventory Update Rule, i.e. Partial Updating of the TSCA Inventory Data Base Production and Site Reports (40 CFR 710(B)).

Y1 - Indicates an exempt polymer that has a number-average molecular weight of 1,000 or greater.

Y2 - Indicates an exempt polymer that is a polyester and is made only from reactants included in a specified list of low concern reactants that comprises one of the eligibility criteria for the exemption rule.

**U.S. Federal Regulations**

TSCA 12(b) Not applicable

**SARA 313**

Component	CAS-No	Weight %	SARA 313 - Threshold Values %
Hydrochloric acid	7647-01-0	22	1.0

**SARA 311/312 Hazard Categories**

Acute Health Hazard	Yes
Chronic Health Hazard	No
Fire Hazard	No
Sudden Release of Pressure Hazard	No
Reactive Hazard	No

**CWA (Clean Water Act)**

Component	CWA - Hazardous Substances	CWA - Reportable Quantities	CWA - Toxic Pollutants	CWA - Priority Pollutants
Hydrochloric acid	X	5000 lb	-	-

**Clean Air Act**

Component	HAPS Data	Class 1 Ozone Depletors	Class 2 Ozone Depletors
Hydrochloric acid	X		-

**OSHA Occupational Safety and Health Administration**

Not applicable

Component	Specifically Regulated Chemicals	Highly Hazardous Chemicals
Hydrochloric acid	-	TQ: 5000 lb

**CERCLA**

Component	Hazardous Substances RQs	CERCLA EHS RQs
Hydrochloric acid	5000 lb	5000 lb

**California Proposition 65** This product does not contain any Proposition 65 chemicals**U.S. State Right-to-Know Regulations**

Component	Massachusetts	New Jersey	Pennsylvania	Illinois	Rhode Island
Water	-	-	X	-	-
Hydrochloric acid	X	X	X	X	X

**U.S. Department of Transportation**

Reportable Quantity (RQ):	N
DOT Marine Pollutant	N
DOT Severe Marine Pollutant	N

**U.S. Department of Homeland Security**

This product contains the following DHS chemicals:

Component	DHS Chemical Facility Anti-Terrorism Standard
Hydrochloric acid	0 lb STQ (anhydrous); 11250 lb STQ (37% concentration or greater)

**Other International Regulations****Mexico - Grade** No information available

## Canada

This product has been classified in accordance with the hazard criteria of the Controlled Products Regulations (CPR) and the MSDS contains all the information required by the CPR

WHMIS Hazard Class

E Corrosive material

**16. Other information**

## Prepared By

Regulatory Affairs  
Thermo Fisher Scientific  
Email: EMSDS.RA@thermofisher.com

## Creation Date

24-Aug-2009

## Revision Date

24-Feb-2014

## Print Date

24-Feb-2014

## Revision Summary

This document has been updated to comply with the US OSHA HazCom 2012 Standard replacing the current legislation under 29 CFR 1910.1200 to align with the Globally Harmonized System of Classification and Labeling of Chemicals (GHS)

## Disclaimer

The information provided in this Safety Data Sheet is correct to the best of our knowledge, information and belief at the date of its publication. The information given is designed only as a guidance for safe handling, use, processing, storage, transportation, disposal and release and is not to be considered a warranty or quality specification. The information relates only to the specific material designated and may not be valid for such material used in combination with any other materials or in any process, unless specified in the text

**End of SDS**

# Hazardous Chemicals

---

## Hazardous Chemicals

The laboratory is a chemical use area for potentially hazardous compounds. The following are the hazard classes of chemicals used in this course and for which this laboratory is designated as a use area:

1. **Carcinogens**
2. **Corrosives**
3. **Flammable and combustible solids and liquids**
4. **Reproductive Toxins**



## Hazardous Waste

**Cation Metal Waste:** Label is **WHITE** and is used in all CHEM 2 courses.

<b>DO NOT FILL ABOVE THIS LINE</b>	
<b>HAZARDOUS WASTE</b> Chem 2 Experiment <b>Cation Metal Waste</b>	
<b>Follow these instructions:</b> <ul style="list-style-type: none"><li>➤ Cap lid when not in use</li><li>➤ Leave in fume hood</li><li>➤ Call Dispensary when full</li></ul>	
<b>FOR WASTE ONLY</b>	Chemical Waste Composition: Aluminum, Bismuth, Chromium, Cobalt, Copper, Iron, Lead, Manganese, Silver, Zinc,
<b>DANGER</b>	
	



**Dithizone in Chloroform Waste:** Label is **BLUE** and is used only in CHEM 2C.

<p><b>KEEP BOTTLE UNCAPPED DO NOT REMOVE FROM FUMEHOOD CALL DISPENSARY WHEN FULL</b></p>
<p><b>HAZARDOUS WASTE</b> Chem 2C Experiment <b>Qualitative Analysis</b></p>
<p>Chemical Waste Composition: <b>Chloroform, Acetone, Dithizone</b></p>
<p><b>WASTE ONLY</b> DO NOT LEAVE BOTTLE UNCAPPED <i>-Flammable- Toxic</i></p> <p> </p>

# Statistical Treatment of Data

---

Every measurement made in the laboratory is subject to error. Although you should try to minimize error, two types of errors will occur. Systematic or Determinate Errors are those errors which are reproducible and which can be corrected. Examples are errors due to a miscalibrated piece of glassware or a balance that consistently weighs light. Random or Indeterminate Errors are due to limitations of measurement that are beyond the experimenter's control. These errors cannot be eliminated and lead to both positive and negative fluctuations in successive measurements. Examples are a difference in readings by different observers, or the fluctuations in equipment due to electrical noise.

You will be graded by your ability to obtain accurate results. Accuracy describes how close your result is to the true value. Another related term is precision. Precision describes how close your results from different trials are to each other. Data of high precision indicates small random errors and leads experimenters to have confidence in their results. Data that is highly accurate suggests that there is little systematic error. A well-designed experiment (and a well-trained experimenter) should yield data that is both precise and accurate.

In an effort to describe and quantify the random errors which will occur during the course of the Chemistry 2 laboratory you will be asked to report an average, a standard deviation, a 90% confidence limit, and a relative deviation. You may also have to analyze multiple trials to decide whether or not a certain piece of data should be discarded. The following sections describe these procedures.

## 1. Average and Standard Deviation

The average or mean,  $\bar{x}$ , is defined by

$$\bar{x} = \frac{\sum x_i}{n}$$

where each  $x_i$  is one measurement and  $n$  is the number of trials.

The standard deviation,  $s$ , measures how close values are clustered about the mean. The standard deviation for small samples is defined by

$$s = \sqrt{\frac{\sum (x_i - \bar{x})^2}{n - 1}}$$

The smaller the value of  $s$ , the more closely packed the data is about the mean—or, in other words, the measurements are more precise.

## 2. Confidence Limits

In general chemistry with a relatively small number of trials, we use a *t-distribution* (also called *Student t-distribution*) for a population mean estimation.

The *t-statistic* is determined by

$$t = \frac{\bar{x} - \mu}{\frac{s}{\sqrt{n}}}$$

where  $\bar{x}$  is the sample mean,  $\mu$  is the population mean,  $s$  is the standard deviation, and  $n$  is the sample size. The *t-statistic* distribution is called the *t-distribution*. The *t-distribution* approximates the normal distribution curve as the sample size increases ( $n$ ).

The particular *t-distribution* is determined by the number of degrees of freedom. For the purposes of estimating the mean from a sample in the general chemistry experiments, the degree of freedom is calculated as the number of independent trials minus one. Then, the *t-distribution* determined by the specified  $n - 1$  degrees of freedom represents the sample mean distribution with respect to the true mean divided by  $\frac{s}{\sqrt{n}}$ . Using this information, an experimenter can formulate a confidence limit for that mean.

Confidence limits provide an indication of data precision. For example, a 90% confidence limit of  $\pm 2.0$  indicates that there is a 90% probability that the true average of an infinite collection of data is within  $\pm 2.0$  of the calculated average of a limited collection. Clearly, the more precise a set of data, the smaller the confidence interval. Thus, a small confidence interval is always the goal of any experiment. In General Chemistry, you will be required to calculate the 90% confidence interval for all experimental collections of data. The formula to do this is:

$$\text{Confidence Limit} = (t_{\text{critical}}) \left( \frac{s}{\sqrt{n}} \right)$$

where  $s$  is the standard deviation,  $n$  is the number of trials, and  $t_{\text{critical}}$  is the critical value in a *t-distribution* table in statistics. A small section of the *t-distribution* table is shown at the end of this section. For the calculation of 90% confidence limits in General Chemistry, please use the following values:

Number of Trials ( $n$ )	$t_{\text{critical}}$
2	6.314
3	2.920
4	2.353
5	2.132
6	2.015

You should always report your result as the average  $\pm$  the 90% confidence limit.

**t-distribution table**

Confidence level n	90%	95%	99%
2	6.314	12.71	63.66
3	2.920	4.303	9.925
4	2.353	3.182	5.841
5	2.132	2.776	4.604
6	2.015	2.571	4.032
∞	1.645	1.960	2.576

### 3. Relative Deviation

The relative average deviation,  $d$ , like the standard deviation, is useful to determine how data are clustered about a mean. The advantage of a relative deviation is that it incorporates the relative numerical magnitude of the average.

The relative average deviation,  $d$ , is calculated in the following way.

- a.) Calculate the average,  $\bar{x}$ , with all data that are of high quality.
- b.) Calculate the deviation,  $|x_i - \bar{x}|$ , of each good piece of data.
- c.) Calculate the average of these deviations.
- d.) Divide that average of the deviations by the mean of the good data.

This number is generally expressed as parts per thousand (ppt). You can do this by simply multiplying by 1000.

Please report the relative average deviation (ppt) in addition to the standard deviation in all experiments.

### 4. Analysis of Poor Data: Q-test

Sometimes a single piece of data is inconsistent with other data. You need a method to determine, or test, if the data in question is so poor that it should be excluded from your calculations. Many tests have been developed for this purpose. One of the most common is what is known as the Q-test. To determine if a data should be discarded by this test you first need to calculate the difference of the data in question from the data closest in value (this is called the “gap”). Next, you calculate the magnitude of the total spread of the data by calculating the difference between the data in question and the data furthest away in value (this is called the “range”). You will then calculate the  $Q_{Data}$ , given by

$$Q_{Data} = \frac{gap}{range}$$

and compare the value to that given in the table below. The values in the table below are given for the 90% confidence level. If the  $Q_{\text{Data}}$  is greater than the  $Q_{\text{Critical}}$  then the data can be discarded with 90% confidence (the value has a less than 10% chance of being valid).

<b>Number of Trials</b>	<b><math>Q_{\text{Critical}}</math></b>
3	0.94
4	0.76
5	0.64
6	0.56

While the Q test is very popular, it is not always useful for the small samples you will have (you will generally only do triplicate trials).

Keep in mind that you also always have the right to discard a piece of data that you are sure is of low quality. That is, when you are aware of a poor collection. However, beware of discarding data that do not meet the Q test. You may be discarding your most accurate determination!

# An Introduction to Excel

In chemistry, as well as in other analytical sciences, it is important to not only know how to collect quality data, but also know how to analyze and manipulate that data to investigate your hypothesis. A spreadsheet program, such as Microsoft Excel, is an especially helpful tool to use for viewing and manipulating data, as it can be used to quickly perform complex calculations on large sets of data, as well as to rearrange raw data into easy to understand graphical representations.

In this guide, you will learn how to create a basic spreadsheet in Excel, and use formulas to quickly perform calculations on your data. You will also learn how to make graphs for your post-lab reports.

This guide uses Microsoft Excel 2016, which is available as a free download for students via:

► <http://officedownload.ucdavis.edu>

The above link can be accessed by logging in with your campus Kerberos (CAS) account. If you do not wish to download Microsoft Office onto your personal computer, Excel is also available for use at all of the computer labs on campus.

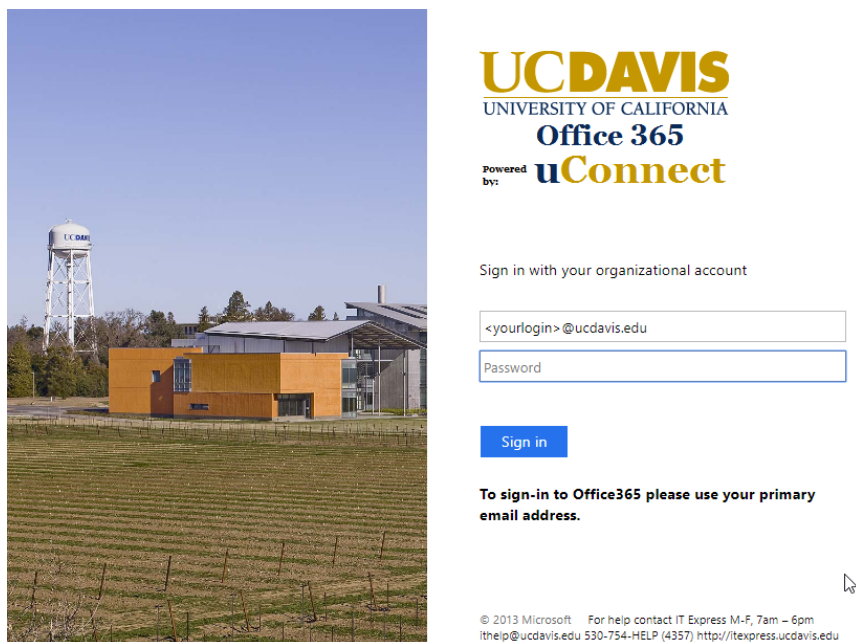

Figure 1. Use your UC Davis login information to access Microsoft Office 365.

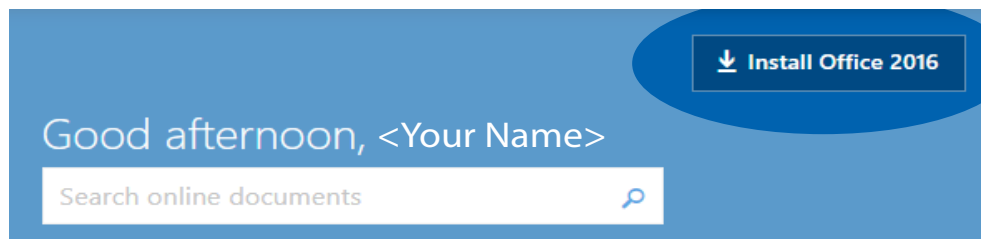

Figure 2. You can install Microsoft Office 2016 by clicking on the “Install Office 2016” button once you’ve logged in.

## Excel Basics

1. Open a new spreadsheet in Excel 2016. The image below shows a section of the blank worksheet.

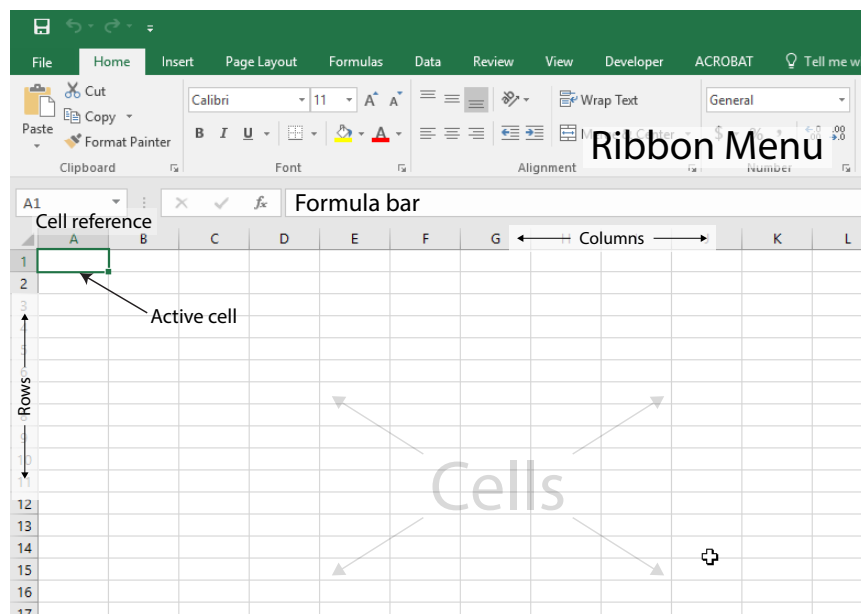

Figure 3. A blank spreadsheet in Excel 2016.

The gray rectangles that make up the spreadsheet are called **cells**, and the **active cell**, or the cell you are currently typing in, has a green outline around it with a handle at the bottom right.

Each cell has its own **cell reference** that consists of the letter of the column and the number of the row it is currently in. The cell reference is analogous to a variable in algebra, where the reference refers to the data inside of the cell. In the image above, the cell reference of the active cell is **A1**.

The **formula bar** displays the formulas in the active cell. If there are no formulas in the active cell, the formula bar displays the text in the cell.

The **ribbon menu** contains a variety of commands to edit and manipulate the data in the spreadsheet. In this guide, we will mainly be using the **Home** and **Insert** menus to edit our spreadsheet.

2. For this section of the guide, we will use sample data from the 2A experiment, *Volumetric Analysis*.

Enter the data in columns, using one cell for each data point. Make sure all the data points from the same trial are in the same row.

In this example, we also include a header row to help keep track of the data columns, although a header row is not required for the program to create graphs or perform calculations.

As you can see in the following image, each row represents a separate trial for the experiment. Column B shows the mass of KHP used, and column C shows the volume of NaOH needed to reach the endpoint.

	A	B	C
1	<b>Trial</b>	<b>Mass KHP (g)</b>	<b>Vol NaOH (mL)</b>
2	1	0.31	16.25
3	2	0.32	15.6
4	3	0.35	16.3
5			
6			

Figure 4. Sample data from 2A, Volumetric Analysis.

3. If we need to enter a series of **equal** intervals, such as a set of increasing wavelengths or time intervals, we can take advantage of Excel's auto-fill feature by using the **fill handle** at the bottom of an active area to quickly enter that series.

Enter the first few values from your series. Then, click on the top-most cell containing data to make it the active cell. Hold the Shift key down and click on the bottom-most cell containing data to select the rest of the data points. The green outline will expand around the entire selected area.

Hover your mouse cursor over the handle at the bottom right of the active area. The cursor will change into a small plus sign (+). Left-click and drag the handle down to another cell in the column to expand the green outline to that cell. A small hover box near the cursor also shows the value that cell will have once the series is expanded.

Let go of the mouse button to fill the selected area with the expanded series. In the following image, notice how the series can be expanded from just two initial values.

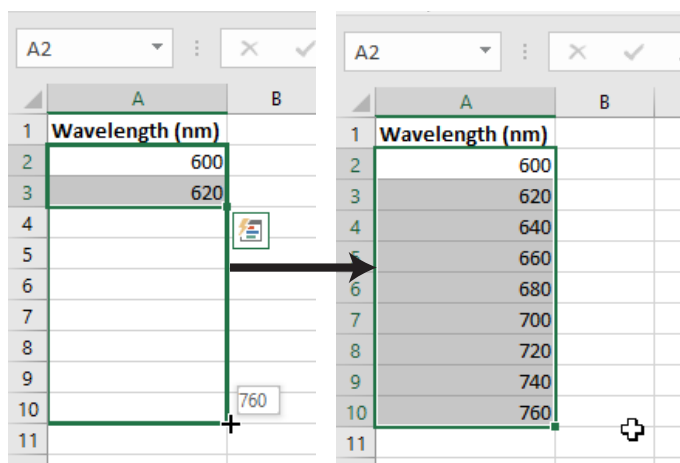

Figure 5. Using the Fill Handle to expand a series of increasing wavelengths.

The fill handle can be used across columns or rows, and can also be used to expand calculations, as you will see in the next section.



4. We may also want to change how many decimal places are displayed in each column or row, depending on what the experiment requires.

To add or remove decimal places, select an area and right click anywhere in that area. Select **Format Cells...** from the context menu to bring up the Format Cells window.

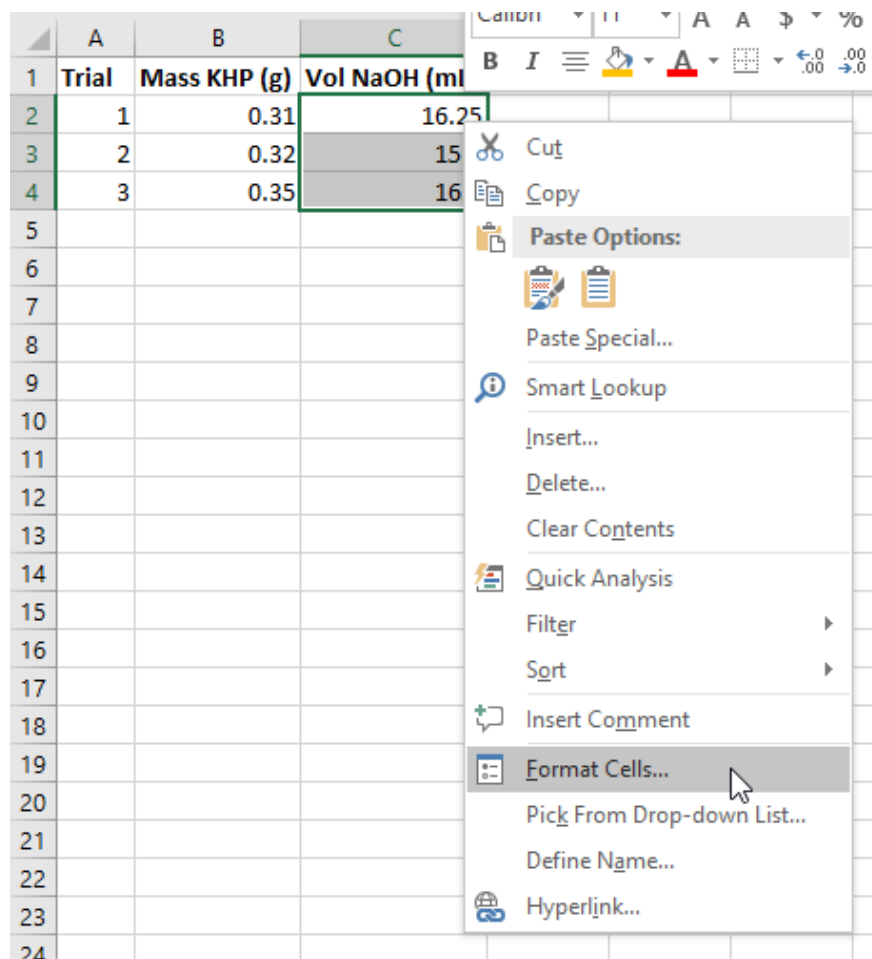

Figure 6. Select Format Cells... from the context menu.

## An Introduction to Excel

The default category for a cell is **General**. Change the category to **Number** and set the number of decimal places as dictated by the experiment.

However, keep in mind that Excel **does not** allow you to set the number of significant figures, so you will still need to remember the rules for rounding significant figures in order to determine the number of decimal places to use.

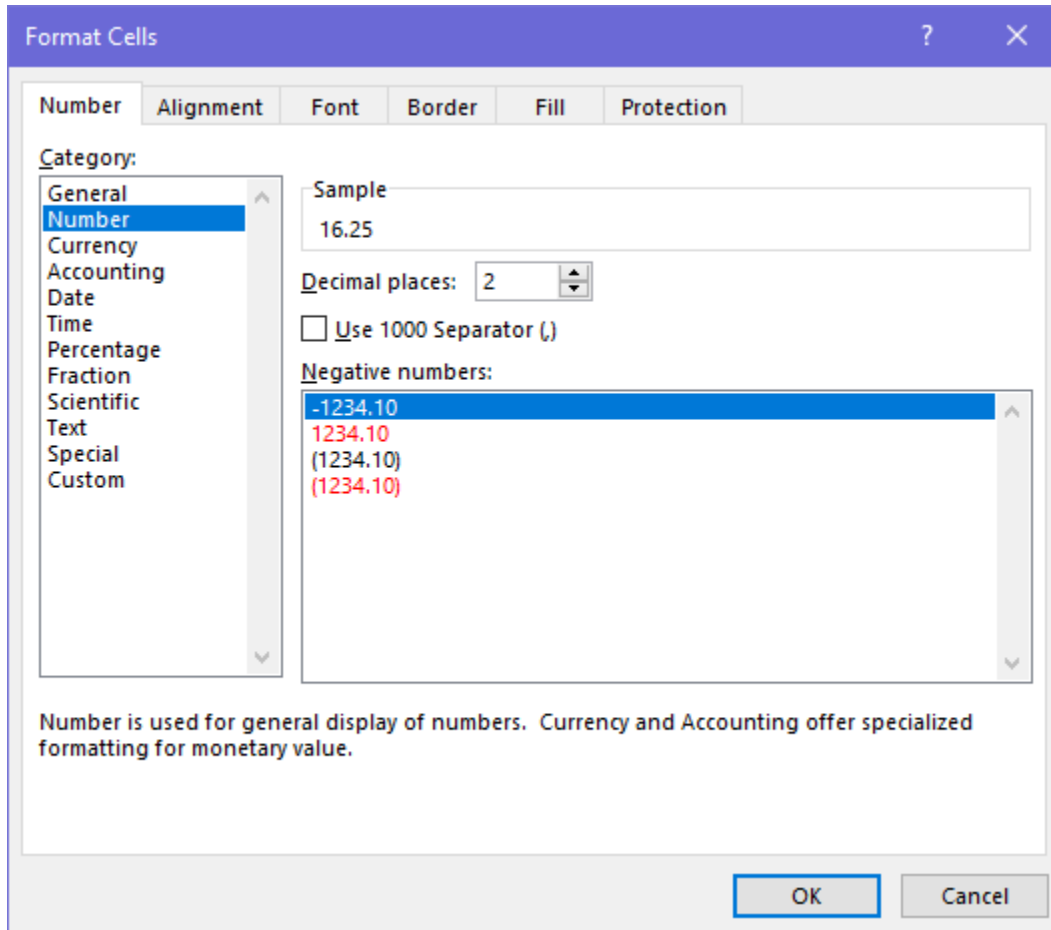

Figure 7. The Format Cells window showing the Number formatting.

## Calculations in Excel

5. Now that we've entered our raw data, we can use Excel to quickly perform calculations with that data using **formulas**.

Excel formulas always start with an equal sign (=). Formulas can use one or more *operators* or *functions*, and can contain a mix of *constants* and *cell references*. Note that Excel formulas using math operators follow the mathematical order of operations.

**Functions** are a type of procedure you can perform in Excel, denoted with an equal sign (=), a function name, such as SUM or AVERAGE, and a set of parentheses containing one or more parameters separated by commas. There are many different functions in Excel, and you can press the *fx* button next to the Formula bar to view the full list. However, in the Chem 2 course, you will most likely only need to use the mathematical functions listed below.

Common math functions for Excel	
=SUM(A1:A5)	Finds the sum of all the cells between cell A1 and cell A5.
=AVERAGE(A1:A5)	Finds the average of the values between cell A1 and cell A5.
=STDEV(A1:A5)	Finds the standard deviation of all the cells between cell A1 and cell A5.

In the *Volumetric Analysis* experiment, we perform multiple titrations of KHP with NaOH to determine the molarity of an NaOH solution. We use the following stoichiometric equation to calculate the molarity of NaOH:

$$\frac{\text{grams KHP} \times \frac{1 \text{ mol KHP}}{204.2 \text{ g KHP}} \times \frac{1 \text{ mol NaOH}}{1 \text{ mol KHP}}}{\text{volume NaOH added (L)}} = \text{Molarity (M)NaOH}$$

We can type this equation as an Excel formula using *cell references* to refer to the data we entered earlier. In this example, the mass of KHP is recorded in column B, and the volume of NaOH added is recorded in column C.

Move to the next blank column in the spreadsheet and give it an appropriate header, such as [NaOH] (M). In the row corresponding to the first trial, type out the formula using cell references to the data points from that trial. Trial 1 is recorded in *row 2*, so we refer to cells **B2** and **C2** in the formula.

Be careful to follow the order of operations and use parentheses to group operations together if needed. Excel will highlight each cell being referenced in a different color, which you can use as a visual guide to double check that you are referring to the correct cells.

	A	B	C	D	E
1	Trial	Mass KHP (g)	Vol NaOH (mL)	[NaOH] (M)	
2	1	0.310	16.25	$=(B2/204.2)/(C2/1000)$	
3	2	0.320	15.60		
4	3	0.350	16.30		
5					

Figure 8. The equation typed into cell D2 as an Excel formula.

Hit the enter key, and the formula will switch to the calculated value. You can double click on the cell to show the formula again if you wish to make any edits.

Now, we can expand that formula to apply to the other rows in the spreadsheet. Click and drag the fill handle down to the bottom-most row of data.

	A	B	C	D
1	Trial	Mass KHP (g)	Vol NaOH (mL)	[NaOH] (M)
2	1	0.310	16.25	0.093422738
3	2	0.320	15.60	
4	3	0.350	16.30	
5				

Figure 9. Click and drag the handle down to the last row of data.

Excel will automatically perform the calculation for every row in the selected area. Note how the cell references are updated for row 4 in the picture below.

	A	B	C	D
1	Trial	Mass KHP (g)	Vol NaOH (mL)	[NaOH] (M)
2	1	0.310	16.25	0.093422738
3	2	0.320	15.60	0.100454557
4	3	0.350	16.30	0.105153735
5				

Figure 10. The formula bar showing the updated cell references.

When you have a large number of trials and you need to use multiple steps in your calculation, it may be easier to do your calculations in Excel rather than on a calculator, because you only need to enter the calculation once.

6. Now, we can use functions in other cells to find the average, standard deviation, and so on. The image below shows the average for each of the 3 columns, again starting from cell B6 and using the fill handle to expand the formula across the 3 columns in row 6.

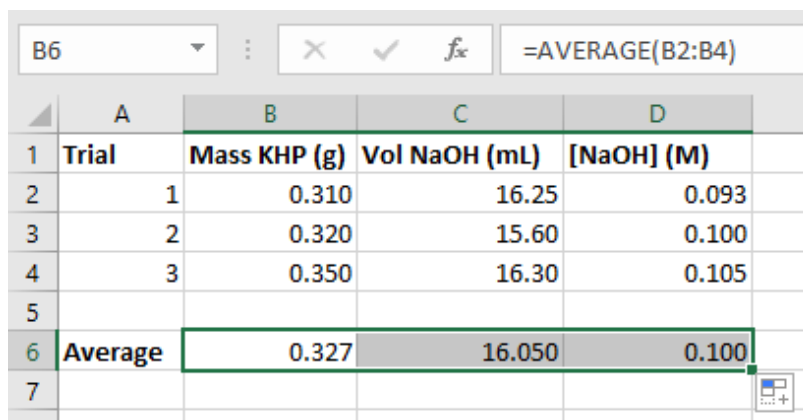

The screenshot shows an Excel spreadsheet with the following data:

	A	B	C	D
1	<b>Trial</b>	<b>Mass KHP (g)</b>	<b>Vol NaOH (mL)</b>	<b>[NaOH] (M)</b>
2	1	0.310	16.25	0.093
3	2	0.320	15.60	0.100
4	3	0.350	16.30	0.105
5				
6	<b>Average</b>	0.327	16.050	0.100
7				

The formula bar above the spreadsheet shows the formula `=AVERAGE(B2:B4)` for cell B6.

Figure 11. The formula bar shows the formula used to calculate the value in the cell.

## Graphing in Excel

7. Excel is also useful for making graphical representations of data. Graphs are an extremely valuable tool in data analysis, because they depict the relationships between data points in a format that is easy to view at a glance.

For this section of the guide, we will use the sample data found at the end of the *Strong Acid - Strong Base Titration* experiment to create a titration curve.

Enter the data in 2 columns, and click on the top leftmost cell containing data. Then, while holding down shift, click on the bottom rightmost cell containing data to select the entire field of data. Then, go to the **Insert** tab of the ribbon menu to find the graphing options.

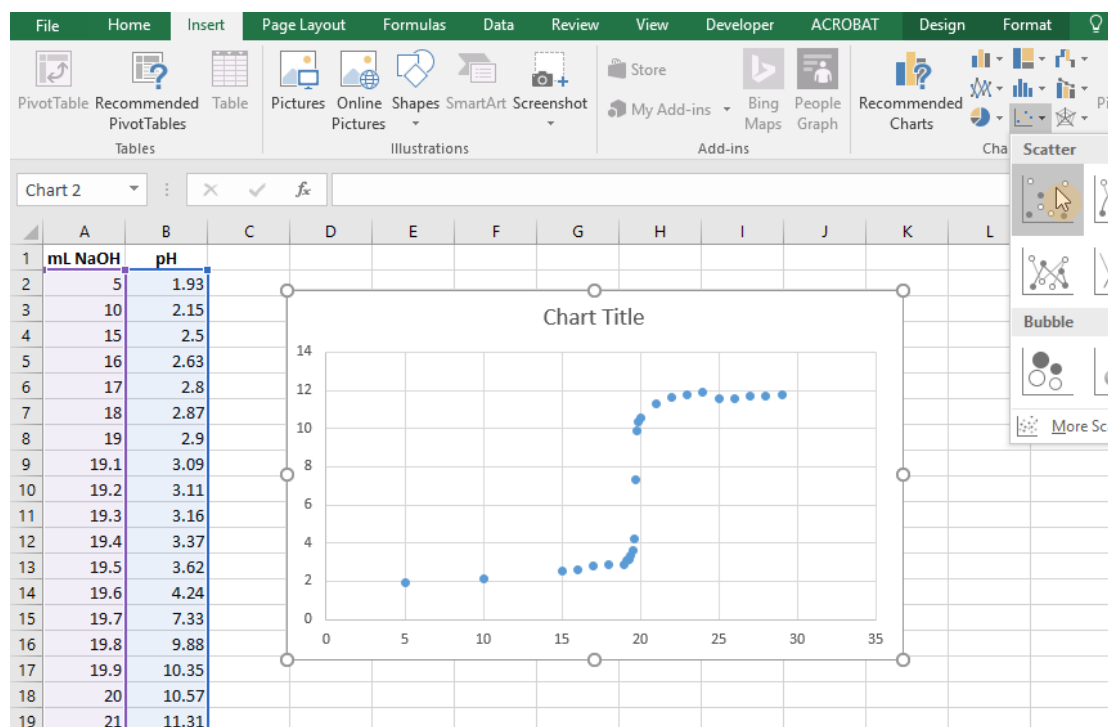

Figure 12. After selecting the data range, go to Insert > Scatter to plot the points on a graph.

There are a variety of different graph types you can create in Excel. In General Chemistry, we will most commonly use the **scatter chart** to create graphs.

With the data range selected, click on the **Insert Scatter (X, Y) Chart button** to plot the points on an xy-axis. This inserts a basic scatter graph into your spreadsheet, but we will want to edit the graph to add more information, such as axes labels or connecting lines.

8. First, let's add some lines to connect the data points and create the titration curve.

You can open up the options menu for the data points by right clicking on any one of the points and clicking on **Format Data Series** from the context menu. A menu will pop up on the right side of the screen.

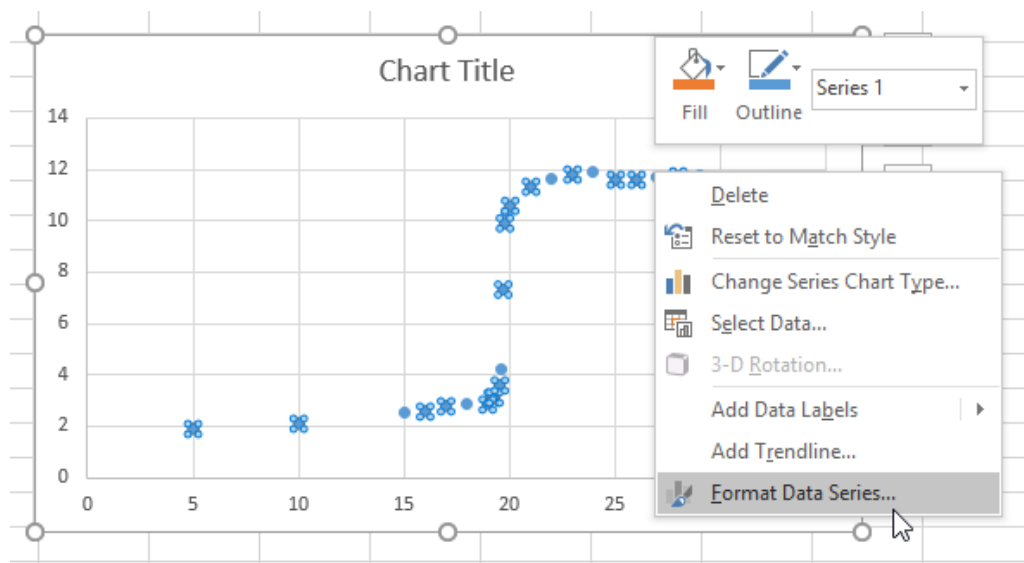

Figure 13. Select Format Data Series from the context menu to access more options.

In the Format Data Series menu, there are options to edit the Line and Marker appearances. You may have to click on the menu text to reveal all of the options.

To add lines between the points, click on the bubble next to **Solid line**.

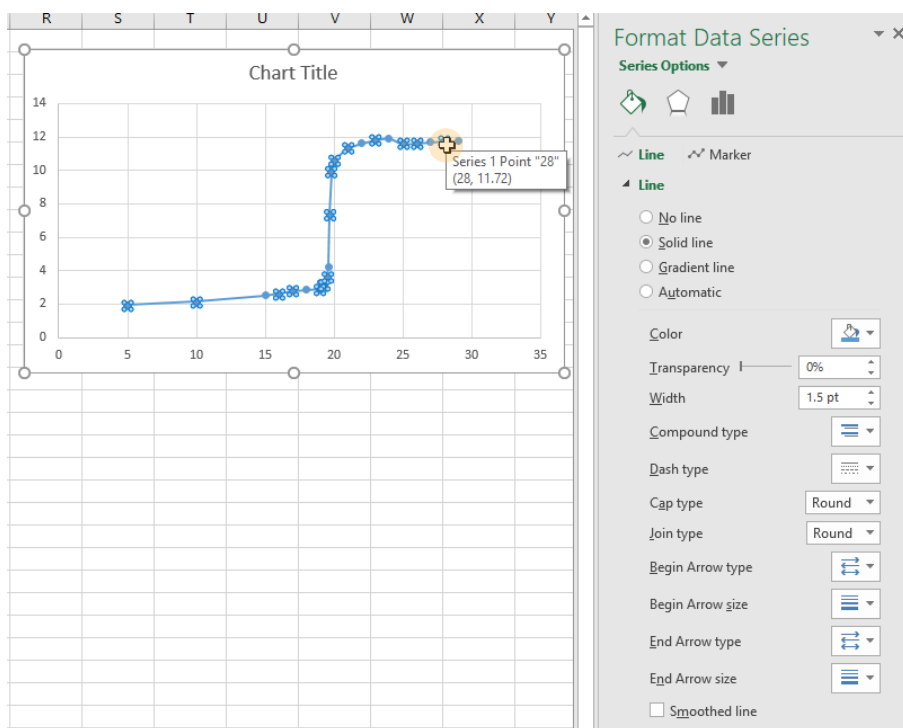

Figure 14. The titration curve with connecting lines added.

- Next, we want to add descriptive labels to the x- and y- axes so others viewing the graph can understand what each axis represents. Select any part of the graph and click on the + button to insert chart elements. Check the box next to **Axis Titles** to insert text fields you can edit next to the x- and y- axes.

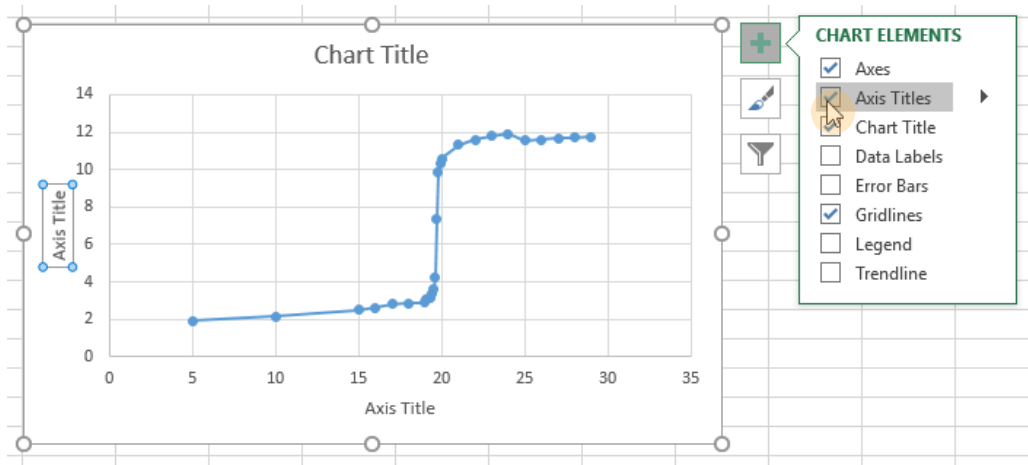

Figure 15. The Chart Elements menu.

Double click on each of the text fields to enable editing. Be sure to include your units in the axis titles, and don't forget to give your graph a descriptive title as well.

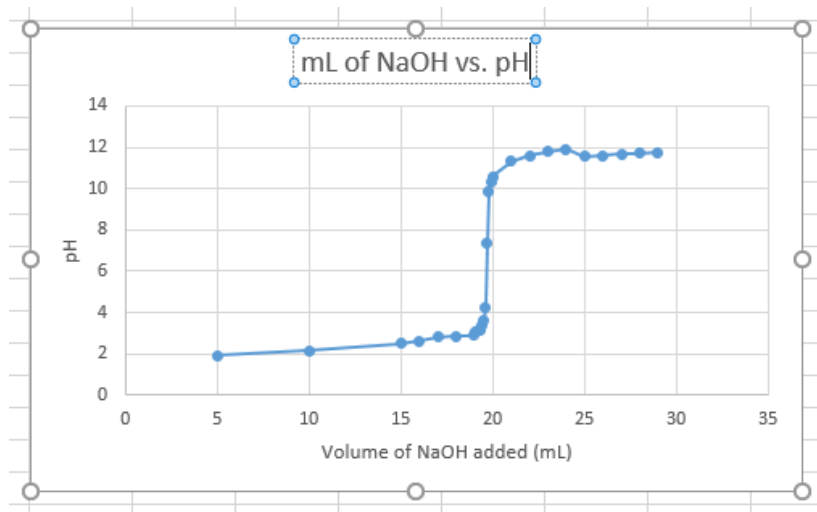

Figure 16. The titration curve with a title and axis labels added.



10. Finally, we can optionally change the range of each axis to minimize the amount of empty space on the graph. Right click on either axis and click on Format Axis to bring up the **Format Axis** options menu. Here, you can change the bounds on the axis to your liking.

On this graph, there are no data points between 0 and 5, and 30 and 35 on the x-axis, so we will change the bounds to 5 and 30. The graph will automatically change to fit the new bounds.

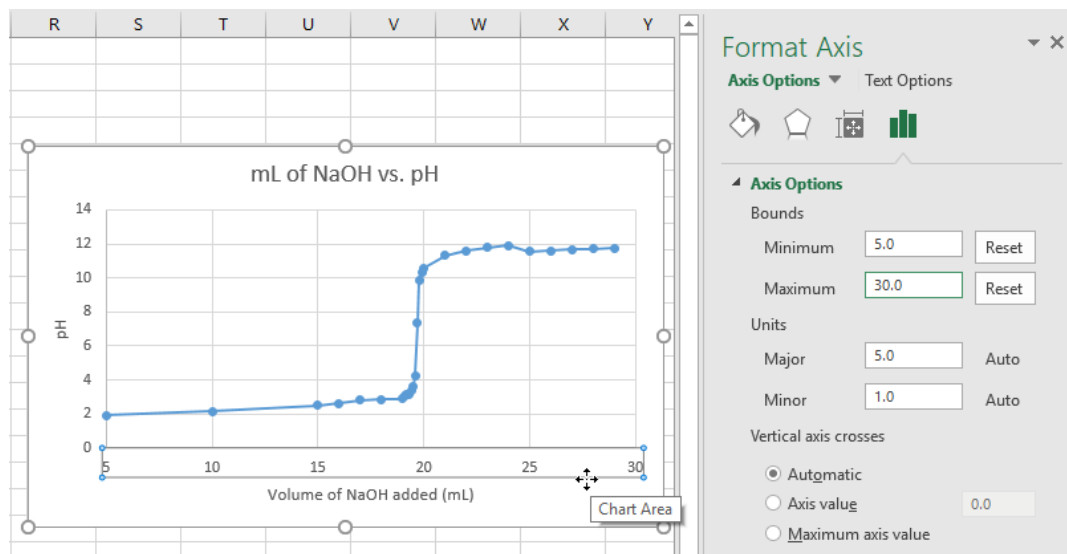

Figure 17. Changing the minimum and maximum bounds of the x-axis.

# Common Laboratory Procedures

---

## Handling Solids

### 1. General Guidelines for Handling Solids

1. Use a **clean** spatula or scoopula to transfer solid from bottles. Never use a contaminated spatula.
2. Never return unused solid to the reagent bottle. To eliminate waste, avoid removing more solid from a bottle than is necessary.
3. Never discard chemicals in the trashcan. Follow waste disposal procedures outlined in the Laboratory Manual.

### 2. Quantitative Transfer

Quantitative transfer refers to the moving of *all the contents* to be transferred from one container to another. Below is an illustration of how to properly weigh and transfer a solid using weighing paper. You will be using weighing boats rather than weighing paper, but the procedure is essentially the same.

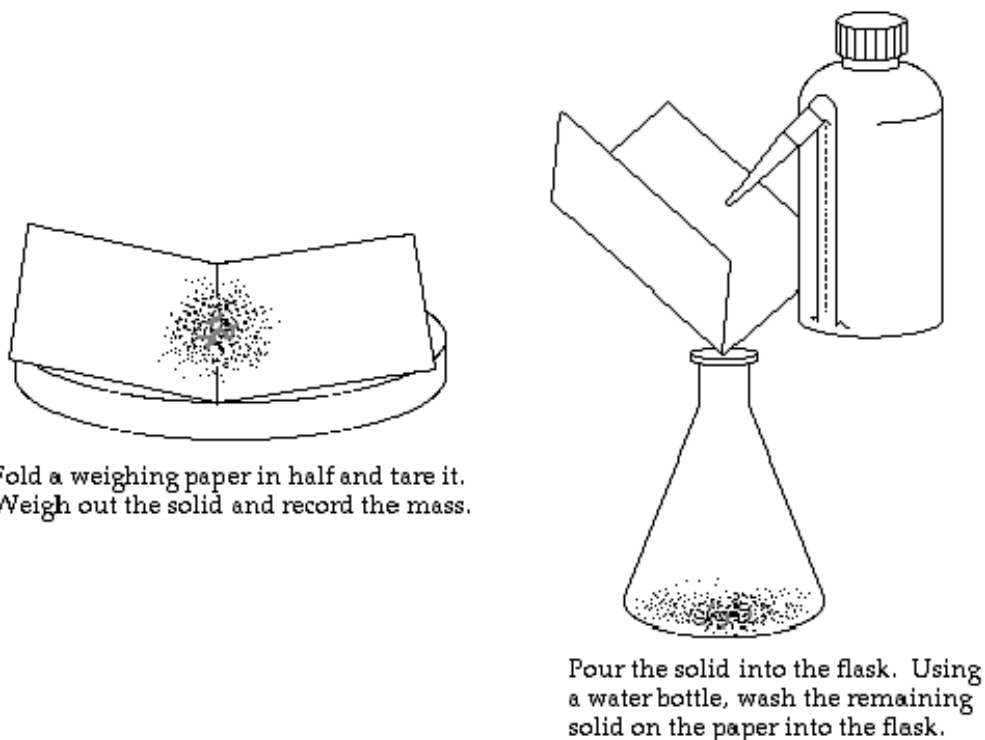

Figure 1. Quantitative Transfer of Solids

### 3. Using the Desiccator

You will occasionally be asked to use the desiccator during the laboratory course to dry some reagents. The desiccator contains some amount of desiccant, which absorbs moisture from air.



a. **Keep the desiccator closed at all times.**

The desiccant will absorb moisture in the air extremely rapidly.

b. **Keep the desiccator tightly sealed with some vacuum grease.**

To apply vacuum grease, put a pea-sized amount of grease on a paper towel and wipe it along the rim of the transparent cover. Make sure you do not use too much grease. Place the cover on top of the base and twist the cover 30 degrees to ensure a tight seal.

#### Desiccator Care

In the Chemistry 2 lab, we use Calcium Chloride as the desiccant. If water is found in the desiccator, discard the desiccant in the sink and rinse with copious amount of water until all solids are dissolved. Wipe the desiccator dry with a paper towel. Make sure all traces of water are removed before refilling from the 10 kg bucket of Calcium Chloride in your lab.

#### Hard to Open Desiccator

Do not try to force open a desiccator. You may accidentally shatter the glassware stored inside. Use an aluminum scoopula as a wedge and push it slowly into the space between the covers.

#### Notice

- Always keep the desiccator upright and closed in your locker.
- Clean up Calcium Chloride spill immediately. Moisture will damage drawers.

## Handling Liquids

### 1. Drawing Solutions from a Reagent Bottle

Most reagent bottles in your laboratory have a small test tube holder attached for a disposable (dispo) plastic pipette. To avoid cross-contamination, always use the assigned dispo pipette to draw solutions from the reagent bottle. Do not use your glass pipet with reagent bottles.

#### Caution

- Improper use of disposable pipets may cause serious injuries!
- Never point the pipet at yourself or others!
- Do not squeeze air into solutions with the dispo pipet. This may result in chemical splashes.
- Always put full dispo pipet in a test tube when carrying it to another part of the lab.

### 2. Estimating Volume with a Dispo Pipet

The dispo pipette may be used to transfer an estimated amount of solution. This is useful when working with non-limiting reagents or quickly making a solution that will be titrated later.

To draw 1 mL of solution into an empty dispo pipet:

- a. Squeeze the bulb to remove some air from the dispo pipet.
- b. Submerge the tip of the dispo pipet in the solution.
- c. Slowly release the pressure on the bulb and draw solution to the 1 mL mark.
- d. Without releasing pressure on the bulb, steadily remove the dispo pipet from the solution.



### 3. Transferring Liquid

- a. When transferring liquids from a reagent bottle, always remove the cap/stopper and hold it in your hand. Never place the cap/stopper on the bench or contamination could result. Pour the liquid slowly and carefully to avoid spillage. You may find the use of a glass rod helpful, as shown below.

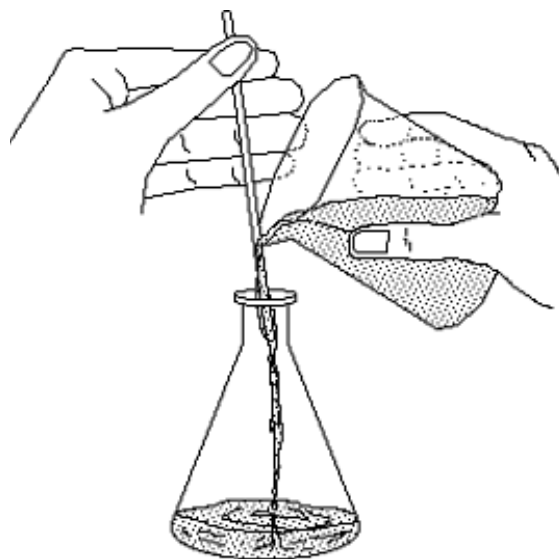

Figure 2. Liquid Transfer with Glass Stir Rod

- b. With the exception of beakers, you should always use a funnel when transferring liquids from a container with a large opening to a container with a small opening.

### 4. Capping a Flask with Parafilm

During many experiments you will have to cap a flask to protect the contents from contamination.

Figure 3. illustrates the proper method using Parafilm.

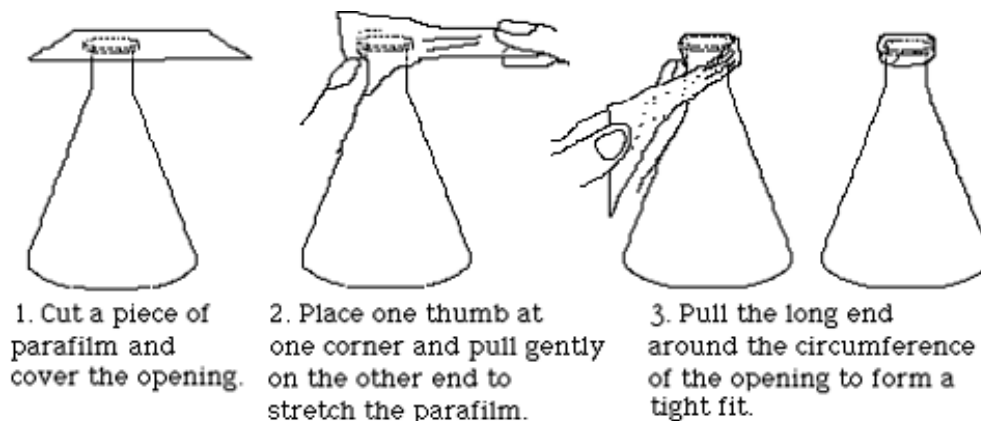

Figure 3. Capping A Flask

### 5. Measuring Liquid Volumes

Many glassware items have volume marks printed on them. Before using a piece of glassware to make a volume measurement, you should take a moment to study its calibrations to insure that you know how to read them properly.

- A beaker or Erlenmeyer flask can be used for rather rough measurements.
- A graduated cylinder can be used for measurements of moderate accuracy.
- A pipet is commonly used to transfer an accurately known volume of a liquid.

However, the accuracy of such a transfer is only as good as the technique of the operator will allow.

In making any volume measurement, the liquid level should always be the same as your eye level. Erlenmeyer flasks and graduated cylinders are usually filled/read by *raising them to your eye level* rather than by squatting down to bring your eye level to the bench top. The liquid level in a pipet is always lowered to the mark while the mark is held steady at eye level.

**Burets:** With practice, the position of the meniscus of a liquid in the 25 mL burets used in the Chemistry 2 labs can be estimated to within 0.02 mL.

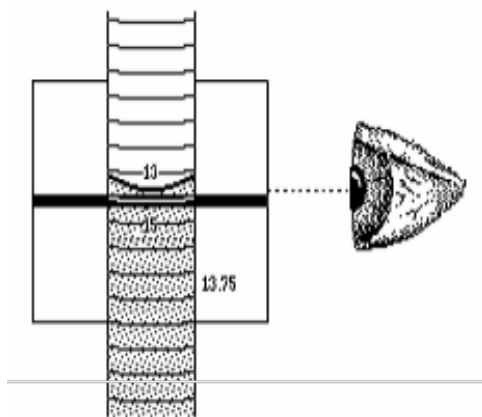

Figure 4. Reading the Meniscus

**Figure 4.** shows the use of a card with a dark strip on it to sharpen the image of the meniscus. You will find by experiment that if the top of the strip is positioned slightly below the level of the liquid in the buret, the bottom of the meniscus will be very easy to see.

## Common Glassware in the Laboratory

Almost all of the glassware used in the Chemistry 2 laboratories are made with borosilicate glass, which is able to resist high temperatures and most chemicals.

### 1. Care and Maintenance of Laboratory Glassware

- a. Always examine the glassware for chips and scratches before use. Damaged glassware may break during normal usage or cause bodily injuries.
- b. Never place glassware near the edge of lab bench. Keep the work area clean and organized to prevent accidents and chemical spills.
- c. Clean broken glassware must be disposed of inside the designated **Glass Disposal Box**. If box is full, ask the dispensary for a new one.
- d. Clean all glassware with water. Make sure to rinse the glassware with DI water as a final step.
- e. Never heat glassware to dryness. Add cold water with your **250 mL water squeeze bottle** when needed.
- f. Never place a heated beaker in an ice bath, or vice versa. Allow the glassware to warm up or cool down gradually.
- g. Never carry lab ware by the neck or cap. Always hold lab ware from the bottom and the side.
- h. Never use tape or sticky labels on laboratory glassware. Always write on the white or blue label area with graphite pencil (a.k.a. “lead pencil”).

### 2. Beakers

Beakers can be used in the laboratory to estimate volume, storing liquids temporarily, and carry out certain reactions.

- Always hold beakers from the bottom or the side. Never hold a beaker by the rim.
- All beakers in the Chemistry 2 laboratories have a pouring lip to make pouring solutions easier.
- All beakers in the Chemistry 2 laboratories have marks for estimating the volume. As noted on the glassware, there is a  $\pm 5\%$  error for the largest volume mark.
- Place a 100 mm watch glass on top of beaker when boiling water to speed up the process.
- If needed, write labels in the frosted areas on the beaker with graphite pencils (a.k.a. “lead” pencils). **Do not use wax pencil or pen!**

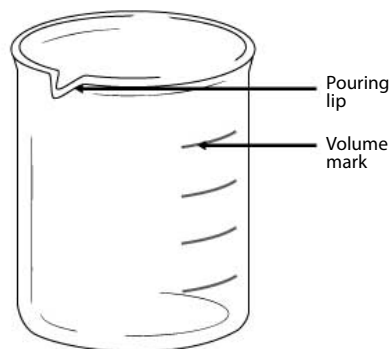

### 3. Erlenmeyer Flasks

Erlenmeyer flasks can be used in the laboratory to estimate volume, storing liquids temporarily, and carry out certain reactions.

- All Erlenmeyer flasks in the Chemistry 2 laboratories have marks for estimating the volume. As noted on the glassware, there is a  $\pm 5\%$  error for the largest volume mark.
- If needed, write labels in the frosted areas on the beaker with graphite pencils (a.k.a. “lead” pencils). **Do not use wax pencil or pen!**

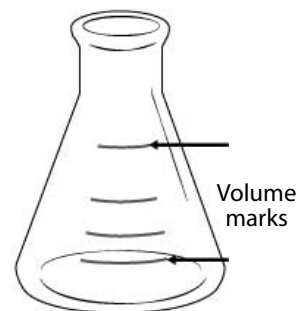

### 4. Graduated Cylinder

Graduated cylinders are used to measure a small volume of liquid with more precision than beakers and Erlenmeyer flasks.

- The graduated cylinders in the Chemistry 2 laboratories include a plastic base and a plastic ring. The plastic ring is to protect the glass cylinder from shattering when the glassware is knocked over. Make sure the plastic ring is placed near the top of the cylinder.
- To quickly measure out a specific amount of water, fill your **250 mL water squeeze bottle** with DI water and squeeze the desired amount of water into the graduated cylinder.

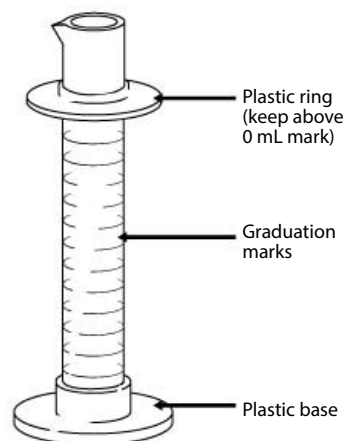



## 5. Volumetric Flasks

Volumetric flasks are very precisely calibrated glassware designed to contain one specific volume of liquid. You will only be allowed to have a limited number of volumetric flasks. If you need to make multiple solutions accurately with a volumetric flask, do not use multiple volumetric flasks. Instead, pour solutions you made in another container and reuse the same volumetric flask.

- The 250 mL volumetric flask used in the Chemistry 2 laboratories has only one graduation mark for volume of 250 mL. As noted on the glassware, there is a  $\pm 0.12$  mL error at 20 °C.
- To fill a volumetric flask to the mark, quickly fill the flask to where the round base meets the neck. Cap the bottle and swirl or invert if needed. Then use a **250 mL water squeeze bottle** to fill to the volume mark. Notice that the volume between the neck and the 250 mL volume mark is only 10 mL.
- Never use glass pipets or dispo pipets to draw solutions from volumetric flasks. Pipets will become stuck inside the flasks.

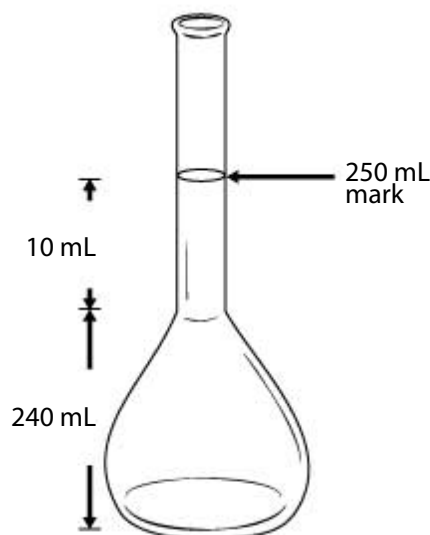

## 6. Burets

Burets are used to deliver a precise amount of solution. Unlike the volumetric flask and graduated cylinder, which are calibrated to measure the liquid contained in the glassware, burets are calibrated to measure the liquid delivered from the glassware. In the Chemistry 2 labs, the buret is mostly used for titrations.

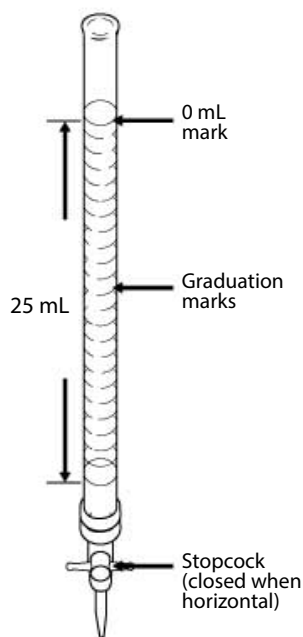

### a. Filling the buret:

- Always use a small beaker (100 mL or 150 mL) to transfer liquid into the buret. A funnel may be used to prevent spills as long as it is cleaned immediately after.
- Remove the buret from the buret clamp and hold it over a sink, below eye level.
- Check to make sure the stopcock is in the closed position.
- Hold the buret slightly below the 0mL mark with one hand. With your other hand, slowly pour the solution from the beaker into the buret. Stop before the liquid level reaches 0 mL.
- If you used a funnel, place the funnel in the sink to clean.
- Replace the buret back in the buret clamp.

### b. Cleaning the buret:

- To clean a buret, fill it to half way with DI water.
- At the sink, open the stopcock and drain out ~10 mL of water and close it. Then invert the buret and open the stopcock and drain out the rest from the top.

### c. Conditioning the buret:

You should always condition your buret with your working solution before using it.

- Clean the buret with DI water.
- Fill the buret with 8-10 mL of the solution to be used. Open the stopcock to drain out a small amount from the tip into an appropriate waste container.
- Cap the top end with Parafilm. At the sink, hold the top of the buret between the thumb and finger of one hand, and hold the tip of the buret with another. Turn the buret horizontal and rotate the tip of the buret. Make sure all sides of the buret are washed with the solution.
- Pour the remaining solution in the buret into an appropriate waste container.

### d. Dispensing solution from the buret:

- First, fill the buret with your solution to near the 0mL mark, but do not attempt to fill it to exactly 0.00 mL. Open the stopcock and drain out a very small amount to ensure no air bubbles exist in the tip. Record in your lab notebook your buret initial reading.
- Open the stopcock and drain the solution. Stop when the target volume is reached. Record the buret final reading in your lab notebook. The difference between the **initial reading** and the **final reading** is the volume dispensed.
- To dispense in small quantities, quickly turn the stopcock clockwise exactly 180 degrees. Repeat as needed.

## 7. Volumetric Pipet

Similar to the buret, the volumetric pipet is designed to deliver a precise amount of solution.

- The volume of liquid each pipet is designed to deliver is labeled on the glassware. Use the volumetric pipet *only* when you need to deliver the exact amount of solution with precision.
- There is a bottle of volumetric pipet cleaning solution in each laboratory. Draw the cleaning solution into the pipet with a pipet bulb and dispel the solution
- To condition a volumetric pipet, draw a small amount of your working solution into the pipet just above the volume mark. Drain the solution into an appropriate waste container.
- Follow the illustration on the next page to learn how to use the volumetric pipet. You should practice using deionized water first to become proficient with the techniques.

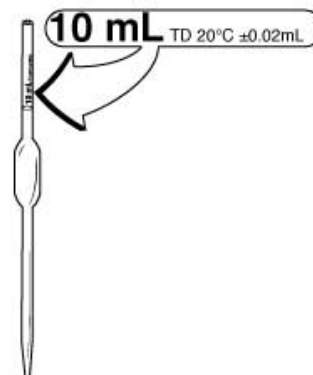

### Caution

- Never mouth pipet. Always use the pipet bulb with tip attached.
- Never point your pipet or pipet bulb at yourself or others.
- Never squeeze air into solutions as it may cause chemical splash.
- Never draw solutions into the bulb. Corrosive solutions will dissolve the rubber and contaminate the pipet.

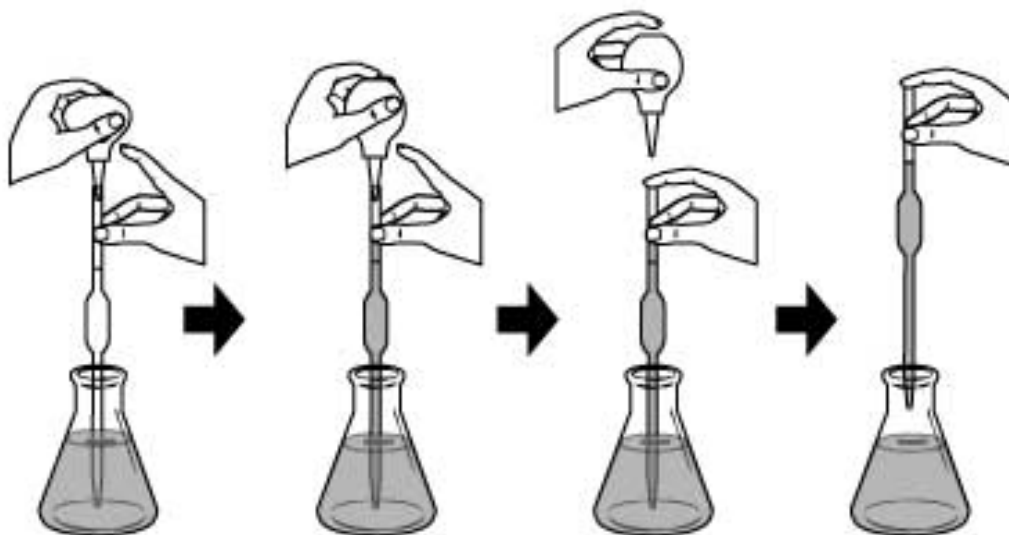

1. To begin:
  - With one hand, hold the conditioned pipet vertical and the pointed end downward inside the container of your working solution. Place your other hand near the top of the pipet and keep the index finger free so that it can easily cap the pipet.
  - With your other hand, deflate the rubber pipet bulb with tip with your thumb.
  - Place the plastic pipet tip on the top of the pipet.
2. To draw the solution:
  - Slowly release your thumb and draw the liquid up the pipet and a few centimeters above the mark on the pipet. Keep the pipet submerged in solution to avoid drawing up air.
  - Lower the pipet so that it reaches the bottom of the container. Quickly remove the **pipet bulb with tip** and cap the pipet with your index finger.
3. To adjust the volume:
  - Raise the over-filled pipet. Raise the mark on the pipet to your eye level, tilt the receiver slightly, and touch the pointed tip of the pipet to a dry spot on its sidewall.
  - Rotate the pipet left and right slightly and let a small amount of air to enter the pipet and thereby allow the meniscus to fall exactly on the volume mark. Be patient, because if you overshoot the mark you must begin the whole process again.
4. To deliver the liquid:
  - Remove the accurately filled pipet from its container. Quickly dry the lower portion of the shaft with a single downward stroke of a laboratory tissue.
  - Tilt the final receiver slightly and while holding the pipet vertical, place its tip against the receiver wall so that when you take your finger off of the pipet mouth, liquid will flow smoothly down to the bottom of the vessel. Avoid splashing.
  - Do not squeeze solution out with the **pipet bulb with tip** and do not blow out the last drop. **The pipet is calibrated to deliver with one last drop left in the pipet.**

## Using the Balance

A balance is used to measure the mass of an object. There are 4 balances assigned to your laboratory section for use in the adjoining balance room. These balances measure the mass to the nearest milligram. You will use these balances for most mass measurements in the Chemistry 2 lab experiments.

There is also a less precise “quick” balance in your lab room, between the fume hoods. You may use this balance to make rough measurements of non-limiting reagents quickly and speed up your experiment without compromising the experiment results.

### 1. On/Off Switching

- a. To turn on the balance, remove all load from the weighing pan and press the **On** button.
- b. To turn off the balance, press and hold the **Off** key for 2 seconds.

### 2. Simple Weighing

Open one of the draft shield sliding doors. Make sure the balance pan and surrounding area is clean. You can clean it with a balance brush or Kimwipe.

Next, shut the doors and press the **O/T button** to set the balance at zero.

Now, simply place the object to be weighed on the weighing pan and measure the mass to 0.001 grams.

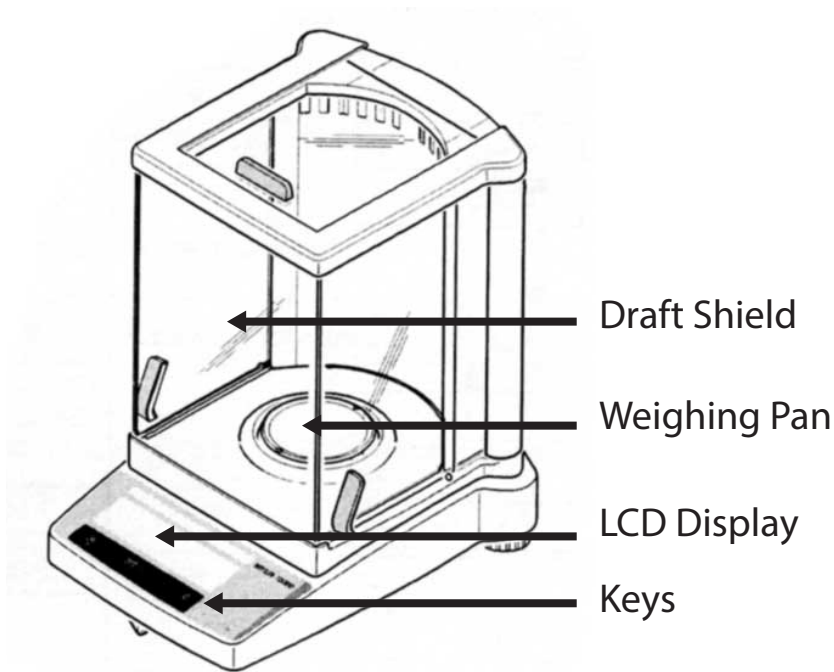

Figure 5. The Analytical Balance

### Notice

- Always use weighing boats when weighing solids to protect the balance. To do this, place the plastic weighing boat on the balance pan and be sure it is not touching the sides.
- Always use the balance with extreme care, as it is very expensive.

### 3. Taring

To measure the mass of sample inside a container, perform the following procedures:

- Place the empty container (e.g. a weighing boat) on the balance.
- Press the **0/T** key briefly. The display should read 0.000 g.
- Add the sample to the container. Read the displayed mass to 0.0001 g.

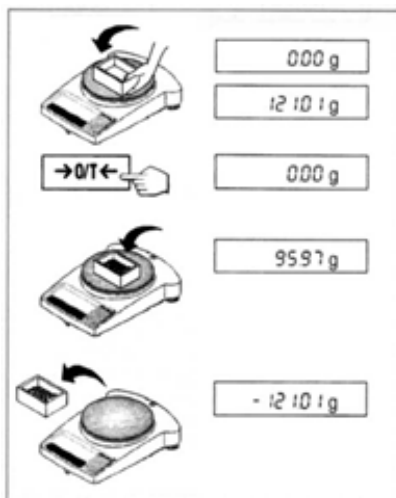

Figure 6. Taring

### 4. Weighing by Difference

To measure the mass of a sample by difference:

- Clear the weighing pan. Press **0/T**. The reading should be 0.000 g.
- Place the container with the sample on the balance. Record the mass.
- Remove a portion of the sample from the container.
- The difference between the two readings is the mass of the removed portion of the sample.

## Using the Centrifuge

A centrifuge machine is used to separate the different constituents of a solution by their density. In many experiments, you will be required to separate precipitation products from solution using the centrifuge machine.

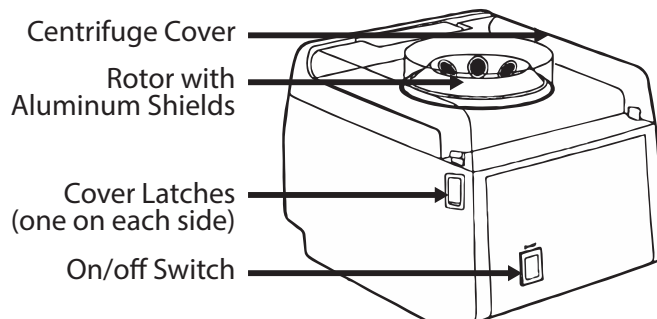

Figure 7. The Centrifuge

### 1. Procedure

- Always load centrifuge tubes of about equal weight. Fill another centrifuge tube with water to equal weight to balance.
- To balance the tubes, place a small beaker on the “quick” balance in your lab room. Weigh your sample tube. Fill another centrifuge tube with water to equal weight (to the nearest 1g).
- Place the centrifuge tubes in the aluminum shields on opposite sides. The centrifuge tubes should fit inside the aluminum shield snugly. Use a different tube if more than 1/8 inch of the glass is exposed.
- Close the cover. Lock both sides securely into the latches.
- Press the On/Off switch to turn on the unit. Press the switch again to turn it off.

#### Warning

- Improper use of the centrifuge machine may result in serious injury. Follow all safety precautions when operating the centrifuge machine.

### 2. Safety Precautions

- Operate the centrifuge only when the cover is securely closed.
- Never open the cover when the centrifuge is running.
- Always balance the tubes before loading. Only spin 2, 4, or 6 tubes.
- Never spin 1, 3, or 5 tubes.**
- Turn off the machine immediately if there are signs that the load is unbalanced.
- Never open the cover before the rotor comes to a **complete** stop.
- Never stop the rotor with your hand. Serious injury may result.

## Using the Hot Plate

The hot plate is used to heat solutions in nearly all experiments performed in the Chemistry 2 laboratory. However, improper use of the hot plate may result in serious injury. Follow all instructions and exercise caution when using the hot plate.

There are a variety of hot plates used in the Chemistry 2 labs, but they all have the same essential features.

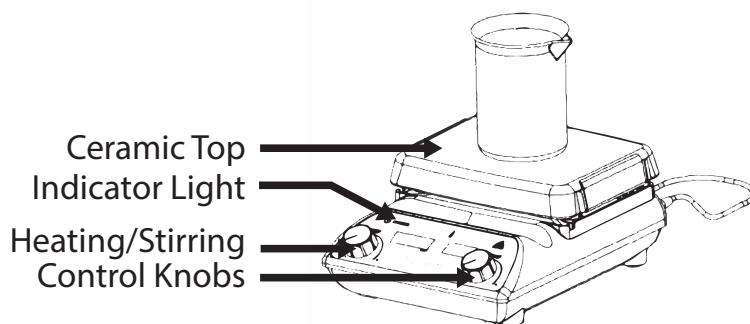

Figure 8. The Hot Plate/Stirrer

### 1. Features

- a. **The Ceramic Top:** The heating surface. The temperature may reach a maximum of over 400 °C. Do not touch the ceramic top. It may cause serious burns. The ceramic top is also very delicate. Clean up spills immediately and avoid hitting the surface with heavy objects.
- b. There are four common indicating lights on all models used in the Chemistry 2 laboratories. They are: the Power Indicator, the Heat Indicator, the Stir Indicator, and the Hot Top indicator.
  - **Power Indicator:** On if the unit is plugged in to a power source. Check power cord connection if not on.
  - **Heat Indicator:** On if the heat is turned on.
  - **Stir Indicator:** On if the magnetic stirrer is turned on.
  - **Hot Top Indicator:** On if the top has a temperature of over 60°C. Do not unplug the unit if the top plate is still hot.

#### Warning

- The hot plate may cause serious burns. Avoid touching the top plate and follow all safety precautions.



## 2. Safety Precautions

- a. Keep the power cord away from the heating surface. The cord may melt and cause an electrical hazard.
- b. Do not hit the top with heavy objects. It may break if impacted.
- c. Do not heat volatile or flammable materials.
- d. Do not operate near volatile or flammable materials.

The hot plate must not be used during this experiment:

- **2B.** Determination of Avogadro's Number
- e. Avoid spilling liquids on the ceramic top. Do not over boil solutions.

It takes approximately 15 minutes to boil 400 mL of water at heat setting 6. Avoid turning the heat setting too high. Spills from over-boiling will damage the hot plate and may result in personal injury.

- f. Never use a container larger than the top plate.
- g. Never boil a solution to dryness.

## Heating with a Bunsen Burner

In using a Bunsen burner, always use a tight blue flame as shown in the illustration below. Always estimate the appropriate height for the iron support ring before turning on the Bunsen burner. Control the heat transfer by adjusting the distance from the burner to the object. Note that the distances suggested in the manual are measured from the hottest part of the flame to the object.

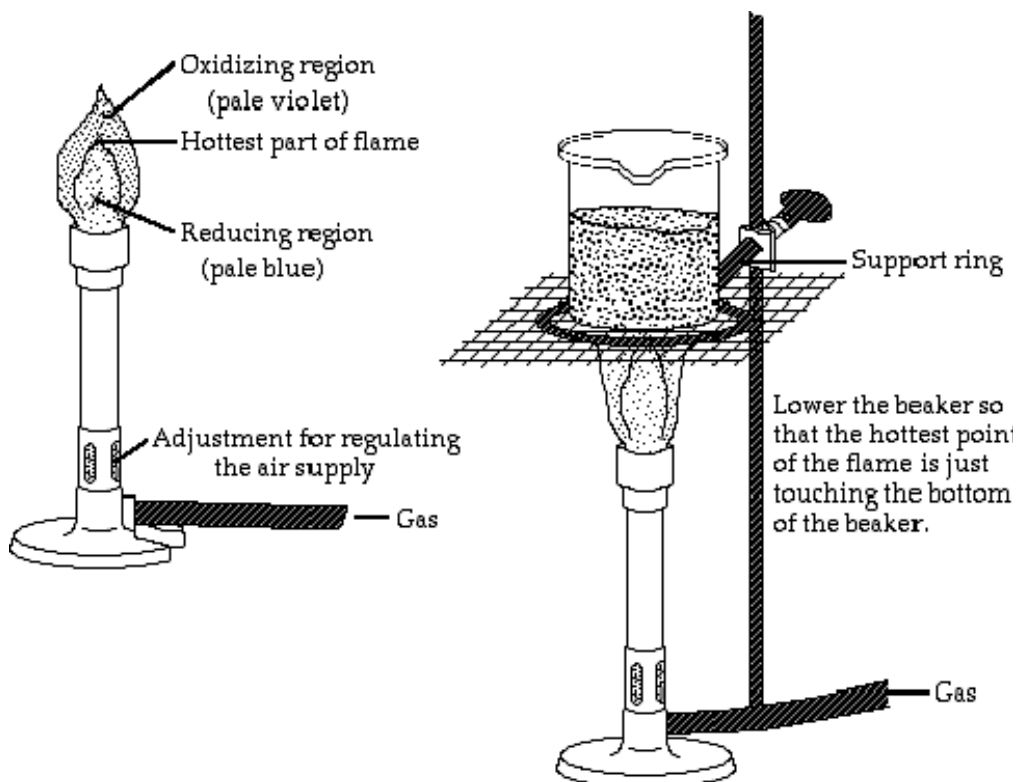
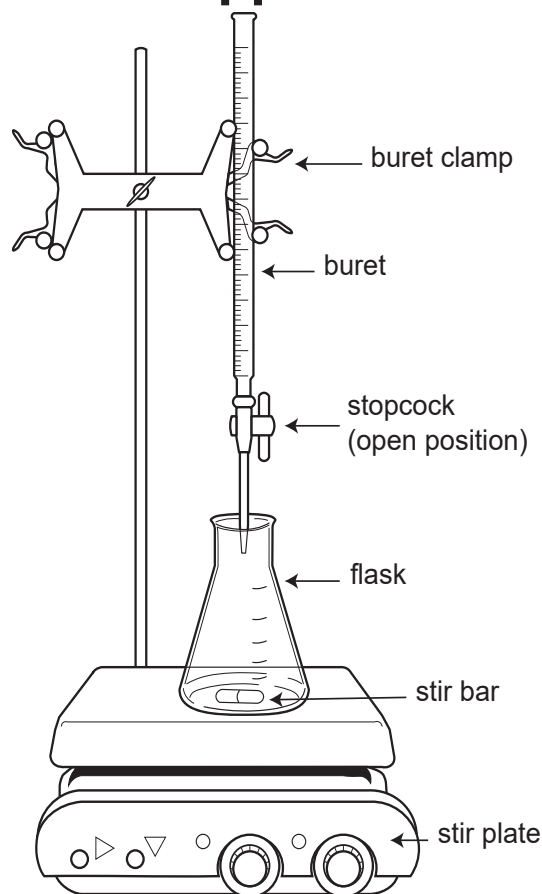

Figure 9. The Bunsen Burner

### Warning

- Only use the Bunsen burner when specifically instructed by the lab manual.
- Keep all flammable materials away from the Bunsen burner.
- Heated lab ware including iron rings can be extremely hot and may cause serious burns!

## Setting up a Titration Apparatus



**Figure 10. Titration Setup**

Titration often involves the use of strong acids and bases, and properly setting up your titration apparatus can reduce the risk of spills or accidents. Reference Figure 10 and the instructions below to properly set up your titration apparatus.

1. Obtain a stir plate, buret, stir bar, and titration flask. Place the stir plate below the buret clamp located at your lab bench. If applicable, make sure the heating element is turned off.
2. After conditioning and filling the buret, place it securely in the buret clamp. Make sure there is enough room between the buret and stir plate to place the titration flask. Adjust the stir plate so that it is centered underneath the tip of the buret.
3. Use a laboratory tissue to wipe down the tip of the buret. Make one quick stroke downward beginning at the closed stopcock and ending in the air beyond the buret tip. Dispose of the tissue as it may now be contaminated.
4. Add your stir bar, solution, and indicator to the titration flask, and place the flask underneath the tip of the buret. Turn on the stirrer and slowly increase the stirring speed.
5. Lower the buret tip into flask without touching the flask sides. You are now ready to titrate.

## Filtration

You will often need to separate a liquid from a solid. At times you will simply decant, that is, you will carefully pour out the liquid, leaving the solid behind. At other times you will need to filter the solution. To do this you will use filter paper and a funnel. You must first fold the paper in order to accelerate the process; this is shown in Figure 7.

You will then set the paper in the funnel using your wash bottle. To do this simply place the paper into the funnel and add a small amount of water to the bottom of the filter.

Slowly add water to the sides with a circular motion to avoid air bubbles between the paper and the funnel. Once the paper has set, transfer the solution to be filtered. If the solid has settled, decant the liquid through the filter first in order to save time.

Never overwhelm the filter; don't add the solution too quickly and never come to within one centimeter of the top of the paper. Transfer the solid using a wash bottle and rubber policeman, and then wash the solid as directed by the experimental procedure.

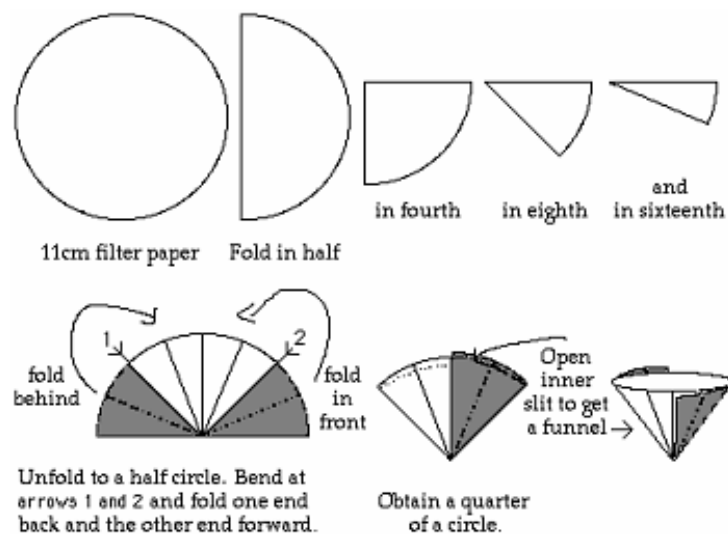

# pH Meter Operating Instructions



## 1. Preparing the pH meter

1. Turn on the pH meter.
2. Meter must be in pH mode. If in mV mode, press the **pH/mV** button.
3. Make sure pH meter is showing  $\bar{\Delta}$ . If not shown, press and hold **Read** button for 2 seconds.
4. Lower left window must show **B1 7.00 4.00 10.01 1.68**. If not, ask your TA to adjust the setting.
5. You may adjust the electrode stand to secure the electrode. Loosen the tension knob to adjust arm position and tighten the tension knob before use.

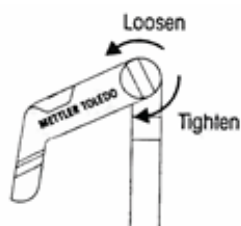
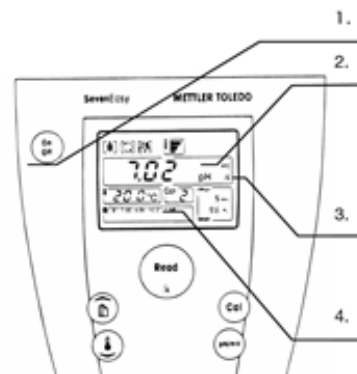

**Caution:** Do **NOT** place test tubes on electrode stand!

6. Do **NOT** let electrode dry out. **Always store electrode in saturated KCl solution when not in use.**

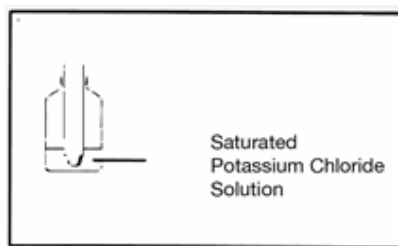

### 2. Calibrating the pH meter

**Note:** You only need to calibrate the pH meter **once** per lab period.

1. Rinse the electrode with DI water.
2. Blot dry with Kimwipe.

**WARNING:** Do **NOT** rub the electrode with Kimwipe. Rubbing the electrode may build up static charge and damage the electrode.

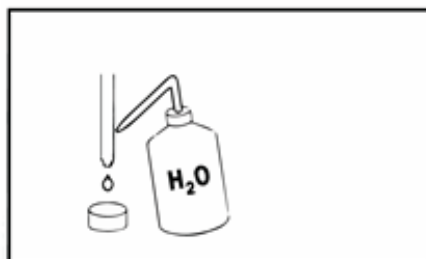

3. Place electrode in pH 7 buffer standard (yellow).
4. Press the **Cal** button.
5. Wait for the display to stop blinking.

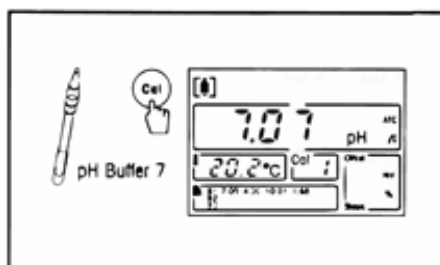

6. Repeat step B-1 to B-5 with the pH 4 buffer standard (red) and then with the pH 10 buffer standard (blue).

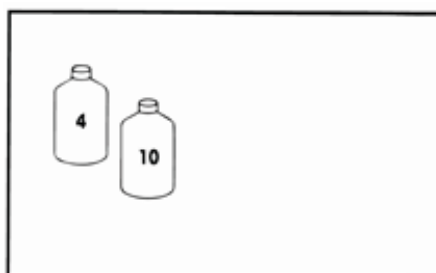

### 3. Measure the pH of sample

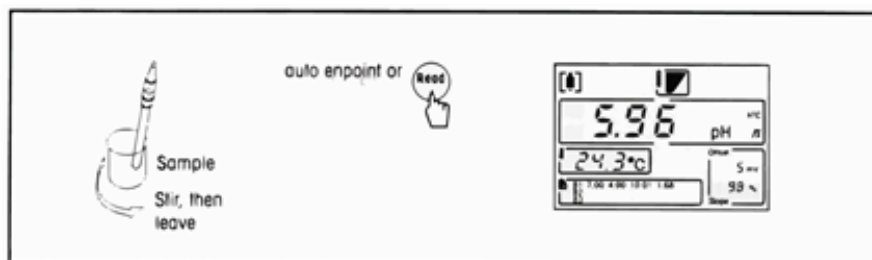

1. After calibration, place the electrode in sample solution and press **Read**.
2. Wait for the reading to stabilize.

## Fume Hood Use and Safety

The fume hoods in the laboratory protect personnel from hazardous materials and inhalation of toxic materials.

### 1. Features of the Fume Hood

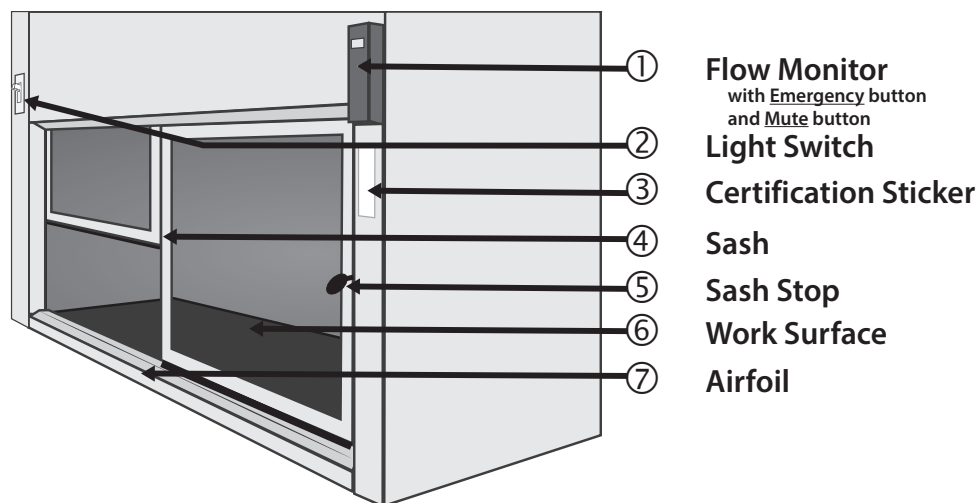

### 2. Before using the fume hood

1. Check the **certification sticker** (③). The Fume Hood is tested and certified every year.
2. Check the flow monitor (①).

Laboratory fume hood should have 100 ft/min face velocity or more. Lower the sash if to increase airflow. If airflow does not reach 100 ft/min, stop work in the fume hood and contact safety personnel immediately.

3. Turn on light switch (②).

### 3. Guidelines for working with the fume hood

1. Lift the sash up slowly about 12 inches. Never raise the sash above the sash stop (⑤).
2. Always place lab equipment at least six inches away from the edge and inside the fume hood as much as possible.
3. Do not rest body parts on the edge or the Airfoil (⑦).
4. Do not place glassware or chemicals on the Airfoil (⑦).
5. Move unused equipment and chemicals away. Remove your glassware when done.

Remember, you are sharing the fume hood with 23 other students. Remove your glassware as soon as possible and clean your glassware. Do **NOT** abandon your lab ware in the fume hood!



6. When increased airflow is needed, press the **Emergency** button and the **Mute** button.
7. **Clean up spills immediately.**
8. **Cap all containers immediately.**
9. Turn off **Emergency** mode and close hood sash all the way at the end of lab.

#### **4. Using the fume hoods in the Chemistry 2 Laboratories**

1. **Always use the fume hood when directed by the Laboratory Manual.**  
Certain reactions in the Chemistry 2 curriculum generate toxic or flammable gases. Follow instructions to protect yourself and others in the lab.
2. Many hazardous chemicals are kept in the fume hood. Never remove these containers unless specifically directed by the Laboratory Manual.
3. All Hazardous Waste containers for the Chemistry 2 course are kept in the fume hood.

#### **5. Fume Hood Emissions**

1. Minimize fume hood emissions to protect the environment and air quality.
2. Never evaporate waste in the fume hood.
3. Minimize use of volatile liquids. Close and seal after using.

**If you have questions, contact your TA or safety coordinator.**

# Locker Inventory

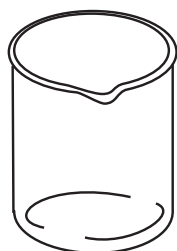

Beaker

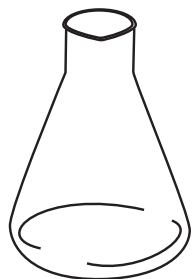

Erlenmeyer Flask

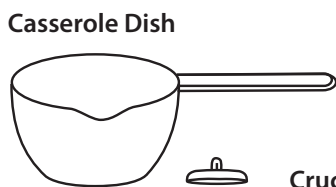

Casserole Dish



Crucible (with Cover)



Test Tube

Centrifuge Tube



Evaporating Dish

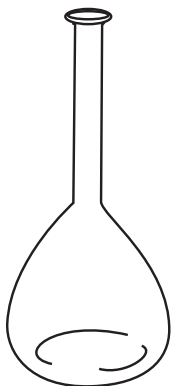

Volumetric Flask

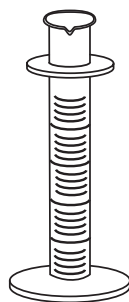

Graduated Cylinder

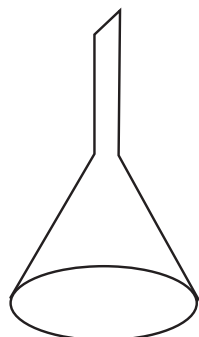

Funnel

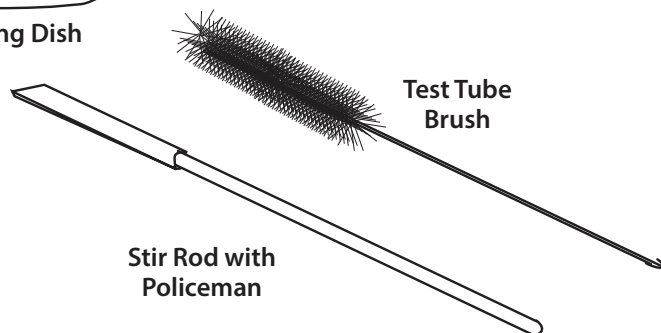

Stir Rod with Policeman

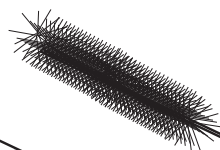

Test Tube Brush



Watch Glass

Wire Gauze

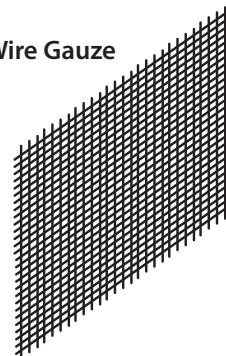

Volumetric Pipet

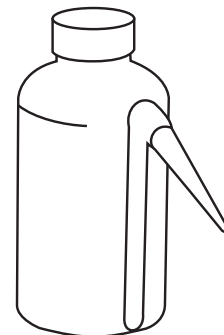

Washing Bottle

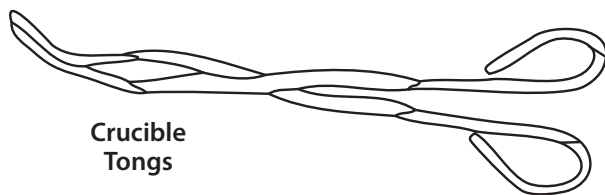

Crucible Tongs

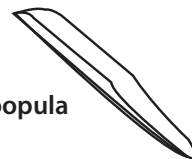

Scoopula

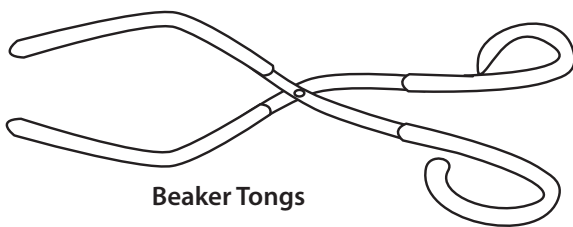

Beaker Tongs

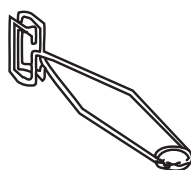

Test Tube Clamp

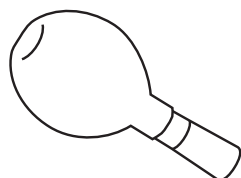

Pipet Bulb with Tip

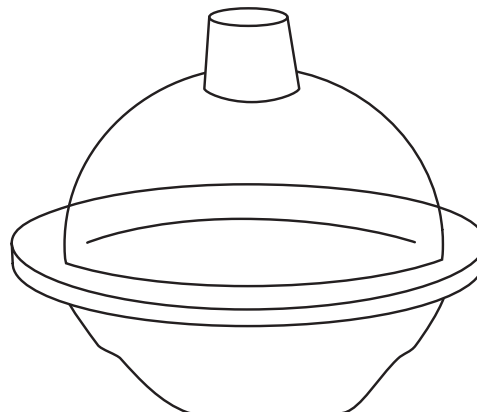

Desiccator

# Locker Inventory

**Procedure for beginning of quarter locker check-in:**

1. Count the numbers of items currently present in locker.
2. Place excess items from locker into the extra glassware box in the back of lab.
3. Return community supplies to the appropriate storage location.
4. Check out missing items from the following sources:
  - a) from the extra glassware box in the back of lab
  - b) from the Dispensary service window (1st floor, Esau Hall 1060E)
5. Clean and dry all equipment.

**CHEMISTRY 2 LOCKER LIST**

Glassware			Porcelain		
# present	# total	Description	# present	# total	Description
	1	100 mL Beaker		1	Casserole Dish
	1	150 mL Beaker		1	Evaporating Dish
	1	250 mL Beaker		2	Crucible
	1	400 mL Beaker		2	Crucible Cover
	1	800 mL Beaker	<b>Plastic Ware</b>		
	2	50 mL Erlenmeyer Flask	# present	# total	Description
	2	125 mL Erlenmeyer Flask		1	250 mL Washing Bottle
	2	250 or 500 mL Erlenmeyer Flask		1	Short Stem Funnel
	1	100 mm Watch Glass		2	1 L Bottle, square
	2	Glass Stir Rod		1	Desiccator
	10	Test Tubes (rounded end)		1	Plastic Test Tube Rack
	6	Centrifuge Tubes (pointed end)	<b>Other</b>		
	2	Thermometer, non-mercury	# present	# total	Description
	2	25 mL Volumetric Flask		1	Centrifuge Tube Brush (pointed)
	1	250 mL Volumetric Flask		1	Test Tube Brush (round)
	1	10 mL Graduated Cylinder		1	Vial, Alkacid Test Paper
	1	25 mL Graduated Cylinder		1	Sponge
<b>Metal Equipment</b>				2	Rubber Policeman
# present	# total	Description			
	1	Wire Gauze Square			
	1	Scoopula			

**COMMUNITY SUPPLIES  
(not in student lockers)**

Lab Island Lockers	Wall Side Drawers
8" Extension Clamp	Beaker Tongs
Clamp Holder	Crucible Tongs
4" Support Ring	Test Tube Clamp
Overhead Storage Cabinet	Bunsen Burner
Pipet Bulb	Silicone Rubber Tubing
1 mL Pipet	Storage Cabinet
5 mL Pipet	25 mL Buret
10 mL Pipet	Drawers Next to Fume Hoods
	Buret Clamps

## Locker Inventory

### Procedure for end of quarter locker check-out:

1. Clean and dry all equipment.
2. Count the numbers of items currently present in locker.
3. Place excess items from locker into the extra glassware box in the back of lab.
4. Return community supplies to the appropriate storage location.
5. Check out missing items from the following sources:
  - a) from the extra glassware box in the back of lab
  - b) from the Dispensary service window (1st floor, Esau Hall 1060E)

### CHEMISTRY 2 LOCKER LIST

Glassware			Porcelain		
# present	# total	Description	# present	# total	Description
	1	100 mL Beaker		1	Casserole Dish
	1	150 mL Beaker		1	Evaporating Dish
	1	250 mL Beaker		2	Crucible
	1	400 mL Beaker		2	Crucible Cover
	1	800 mL Beaker	<b>Plastic Ware</b>		
	2	50 mL Erlenmeyer Flask	# present	# total	Description
	2	125 mL Erlenmeyer Flask		1	250 mL Washing Bottle
	2	250 or 500 mL Erlenmeyer Flask		1	Short Stem Funnel
	1	100 mm Watch Glass		2	1 L Bottle, square
	2	Glass Stir Rod		1	Desiccator
	10	Test Tubes (rounded end)		1	Plastic Test Tube Rack
	6	Centrifuge Tubes (pointed end)	<b>Other</b>		
	2	Thermometer, non-mercury	# present	# total	Description
	2	25 mL Volumetric Flask		1	Centrifuge Tube Brush (pointed)
	1	250 mL Volumetric Flask		1	Test Tube Brush (round)
	1	10 mL Graduated Cylinder		1	Vial, Alkacid Test Paper
	1	25 mL Graduated Cylinder		1	Sponge
<b>Metal Equipment</b>				2	Rubber Policeman
# present	# total	Description			
	1	Wire Gauze Square			
	1	Scoopula			

### COMMUNITY SUPPLIES (not in student lockers)

Lab Island Lockers	Wall Side Drawers
8" Extension Clamp	Beaker Tongs
Clamp Holder	Crucible Tongs
4" Support Ring	Test Tube Clamp
Overhead Storage Cabinet	Bunsen Burner
Pipet Bulb	Silicone Rubber Tubing
1 mL Pipet	Storage Cabinet
5 mL Pipet	25 mL Buret
10 mL Pipet	Drawers Next to Fume Hoods
	Buret Clamps

# Periodic Table of the Elements

18 VIIIA 8A																	
2																	
<b>He</b> Helium 4.003						17 VIIA 7A											
10																	
<b>Ne</b> Neon 20.180						9											
18																	
<b>Ar</b> Argon 39.948						16											
36																	
<b>Kr</b> Krypton 84.798						15											
54																	
<b>Xe</b> Xenon 131.294						14											
86																	
<b>Rn</b> Radon 222.018						13											
118																	
<b>Og</b> Oganesson [294]						12											
18																	
<b>Cl</b> Chlorine 35.453						11											
36																	
<b>Br</b> Bromine 79.904						10											
54																	
<b>I</b> Iodine 126.904						9											
86																	
<b>At</b> Astatine 209.987						8											
118																	
<b>Ts</b> Tennessine [294]						7											
118																	
<b>Og</b> Oganesson [294]						6											
118																	
<b>Og</b> Oganesson [294]						5											
118																	
<b>Og</b> Oganesson [294]						4											
118																	
<b>Og</b> Oganesson [294]						3											
118																	
<b>Og</b> Oganesson [294]						2											
118																	
<b>Og</b> Oganesson [294]						1											
118																	
<b>Og</b> Oganesson [294]						0											
118																	
<b>Og</b> Oganesson [294]						-1											
118																	
<b>Og</b> Oganesson [294]						-2											
118																	
<b>Og</b> Oganesson [294]						-3											
118																	
<b>Og</b> Oganesson [294]						-4											
118																	
<b>Og</b> Oganesson [294]						-5											
118																	
<b>Og</b> Oganesson [294]						-6											
118																	
<b>Og</b> Oganesson [294]						-7											
118																	
<b>Og</b> Oganesson [294]						-8											
118																	
<b>Og</b> Oganesson [294]						-9											
118																	
<b>Og</b> Oganesson [294]						-10											
118																	
<b>Og</b> Oganesson [294]						-11											
118																	
<b>Og</b> Oganesson [294]						-12											
118																	
<b>Og</b> Oganesson [294]						-13											
118																	
<b>Og</b> Oganesson [294]						-14											
118																	
<b>Og</b> Oganesson [294]						-15											
118																	
<b>Og</b> Oganesson [294]						-16											
118																	
<b>Og</b> Oganesson [294]						-17											
118																	
<b>Og</b> Oganesson [294]						-18											
118																	
<b>Og</b> Oganesson [294]						-19											
118																	
<b>Og</b> Oganesson [294]						-20											
118																	
<b>Og</b> Oganesson [294]						-21											
118																	
<b>Og</b> Oganesson [294]						-22											
118																	
<b>Og</b> Oganesson [294]						-23											
118																	
<b>Og</b> Oganesson [294]						-24											
118																	
<b>Og</b> Oganesson [294]						-25											
118																	
<b>Og</b> Oganesson [294]						-26											
118																	
<b>Og</b> Oganesson [294]						-27											
118																	
<b>Og</b> Oganesson [294]						-28											
118																	
<b>Og</b> Oganesson [294]						-29											
118																	
<b>Og</b> Oganesson [294]						-30											
118																	
<b>Og</b> Oganesson [294]						-31											
118																	
<b>Og</b> Oganesson [294]						-32											
118																	
<b>Og</b> Oganesson [294]						-33											
118																	
<b>Og</b> Oganesson [294]						-34											
118																	
<b>Og</b> Oganesson [294]						-35											
118																	
<b>Og</b> Oganesson [294]						-36											
118																	
<b>Og</b> Oganesson [294]						-37											
118																	
<b>Og</b> Oganesson [294]						-38											
118																	
<b>Og</b> Oganesson [294]						-39											
118																	
<b>Og</b> Oganesson [294]						-40											
118																	
<b>Og</b> Oganesson [294]						-41											
118																	
<b>Og</b> Oganesson [294]						-42											
118																	
<b>Og</b> Oganesson [294]						-43											
118																	
<b>Og</b> Oganesson [294]						-44											
118																	
<b>Og</b> Oganesson [294]						-45											
118																	
<b>Og</b> Oganesson [294]						-46											
118																	
<b>Og</b> Oganesson [294]						-47											
118																	
<b>Og</b> Oganesson [294]						-48											
118																	
<b>Og</b> Oganesson [294]						-49											
118																	
<b>Og</b> Oganesson [294]						-50											
118																	
<b>Og</b> Oganesson [294]						-51											
118																	
<b>Og</b> Oganesson [294]						-52											
118																	
<b>Og</b> Oganesson [294]						-53											
118																	
<b>Og</b> Oganesson [294]						-54											
118																	
<b>Og</b> Oganesson [294]						-55											
118																	
<b>Og</b> Oganesson [294]						-56											
118																	
<b>Og</b> Oganesson [294]						-57											
118																	
<b>Og</b> Oganesson [294]						-58											
118																	
<b>Og</b> Oganesson [294]						-59											
118																	
<b>Og</b> Oganesson [294]						-60											
118																	
<b>Og</b> Oganesson [294]						-61											
118																	
<b>Og</b> Oganesson [294]						-62											
118																	
<b>Og</b> Oganesson [294]						-63											
118																	
<b>Og</b> Oganesson [294]						-64											
118																	
<b>Og</b> Oganesson [294]						-65											
118																	
<b>Og</b> Oganesson [294]						-66											
118																	
<b>Og</b> Oganesson [294]						-67											
118																	
<b>Og</b> Oganesson [294]						-68											
118																	
<b>Og</b> Oganesson [294]						-69											
118																	
<b>Og</b> Oganesson [294]						-70											
118																	
<b>Og</b> Oganesson [294]						-71											
118																	
<b>Og</b> Oganesson [294]						-72											
118																	
<b>Og</b> Oganesson [294]						-73											
118																	
<b>Og</b> Oganesson [294]						-74											
118																	
<b>Og</b> Oganesson [294]						-75											
118																	
<b>Og</b> Oganesson [294]						-76											
118																	
<b>Og</b> Oganesson [294]						-77											
118																	
<b>Og</b> Oganesson [294]						-78											
118																	
<b>Og</b> Oganesson [294]						-79											
118																	
<b>Og</b> Oganesson [294]						-80											
118																	
<b>Og</b> Oganesson [294]						-81											
118																	
<b>Og</b> Oganesson [294]						-82											
118																	
<b>Og</b> Oganesson [294]						-83											
118																	
<b>Og</b> Oganesson [294]						-84											
118																	
<b>Og</b> Oganesson [294]						-85											